

Review of Planning Controls 225-277 Broadway, Glebe



Architectus Group Pty Ltd
ABN 90 131 245 684

Nominated Architect
Managing Director Sydney
Ray Brown
NSWARB 6359

Architectus Sydney
Level 8, 341 George Street
Sydney NSW 2000
Australia

T +61 2 8552 8400
F +61 2 8552 8600
Sydney@architectus.com.au

Architectus Melbourne
Level 7, 259 Victoria Parade
East Melbourne VIC 3002
Australia

T +61 3 9455 5777
F +61 3 9472 8400
Melbourne@architectus.com.au
Managing Director Melbourne
Mark Wolfe

www.architectus.com.au



Contents

Contents	3	2	Urban Design Principles	33
Executive Summary	4	2.1	Urban Design Principles	34
1	7	3	Built Form Options	37
1.1	8	3.1	Options Tested	38
1.2	10	3.2	Option 1 – Heritage Integration	40
1.3	12	3.3	Option 2 – Lot Amalgamation	50
1.4	18	3.4	Option 3 – Additional Height	58
1.5	19	3.5	Option 4 – Non-Residential Uses	66
1.6	20	3.6	Shadow Analysis	74
1.7	21	3.7	Public Interface Analysis	78
1.8	22	4	Appendix: Design Development	83
1.9	26	4.1	Generic Typology Studies	84
1.10	27	4.2	Sectional Studies	87
1.11	28	4.3	Exploratory Options Testing	90
1.12	29	4.4	Summary of Areas	97
1.13	30			



Executive Summary

The study area nominated by the City of Sydney presents a range of complex and interrelated challenges for redevelopment. The study area is a composite of multiple, fragmented and irregular lots, largely under separate ownerships with potential heritage items. The area is also flanked on both sides by major sources noise.

A key issue in the viability of new medium and high density residential dwellings in Sydney is noise affected environments. This study tests the suitability of residential uses on a challenging group of sites through an integrated combination of urban design and architecture strategies. The approaches and systems adopted in this study area may be used as a precedent for development in similarly noise-affected urban areas.

The Purpose of this Report

Architectus has been commissioned by the City of Sydney to undertake a review of the existing planning controls for a block of properties, from 225 to 277 Broadway.

It is understood that this document could be used as supporting documentation for investigation to justify potential for additional density and capacity on this site.

Aim of Study

The aim of this study is to investigate and test the delivery of a consistent strategic planning outcome for the properties identified in the study area.

Area of Study

The study area defined by the City of Sydney comprises approximately 4650 square metres over 13 separate lots, which range in size from 151 to 1216 square metres.

The study area currently has two current Planning Proposal interests and requests which seek to alter the planning controls.

Study Objectives:

- Analyse the subject sites, their location within the wider urban context, applicable development controls, and desired future character.
- Understand constraints and opportunity for development, and develop urban design principles to guide the design process.
- Identify three residential development options and one non-residential option that can be tested for positive public and private outcomes. These options include:
 - Option 1 - Heritage
 - Option 2 - Amalgamation
 - Option 3 - Amalgamation (with height)
 - Option 4 - Non-Residential Uses

Key Considerations

The study area is located in a prominent city gateway location. It is elongated east-west with noise and shadowing impacts to the north and south. It also features a number of Victorian, Federation and Inter-war period commercial buildings within the site and is located adjacent to a conservation area. The report seeks to successfully address each of these criteria in order to evaluate the possibility of creating high quality places for living and working, while also contributing to the character of the surrounding urban environment.

Built Form

- Streetscape as public interface
- Residential apartment design, including SEPP 65 considerations, such as daylight access, cross and natural ventilation that mandate a level of design quality.
- Indicative floor space yield

Heritage Features

- Heritage items
- Character areas
- Contributory features

Acoustic Constraints

- Noise attenuation strategies
- Activation of public and private frontages and spaces

Key Outcome

This study has worked to identify and address the issues of amenity which arise as a result of proposing residential development along noisy roads. It has also explored a number of methodologies in design, construction and acoustic engineering in an attempt to mitigate their impact. While it is noted that residential uses are permissible and plausible propositions within the study area, development would have to be contingent on addressing the key constraint of noise in addition to other issues related to amenity. Furthermore, the study has illustrated that the constraints inherent to residential development coupled with constraints of the study area itself would indicate that non-residential uses would be more suitable in terms of amenity and overall floor space yield.

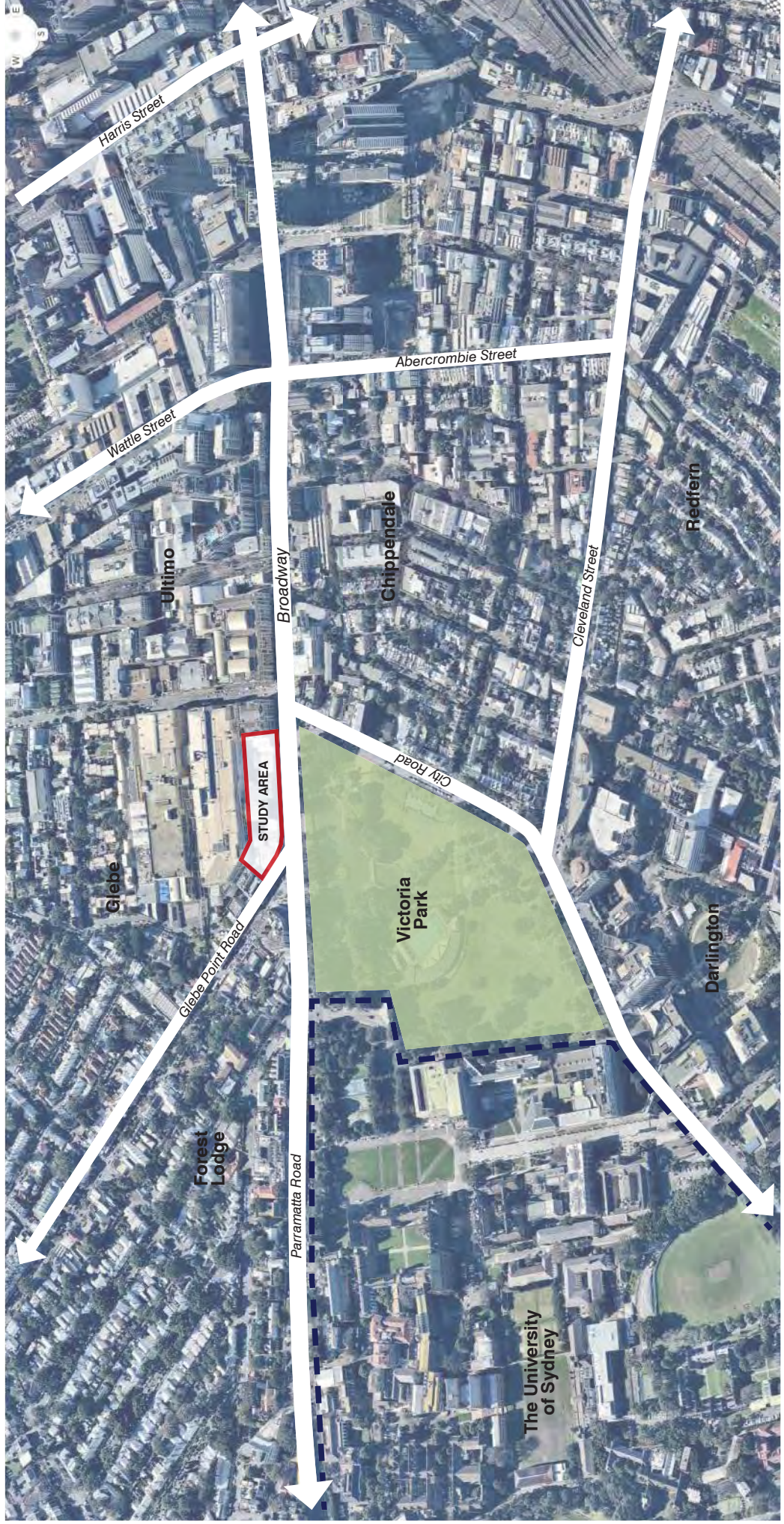



1 Analysis



1.1 Study Area Overview

Study Area Composition

The existing study area is made up of 13 individual lots and stretches from the corner of Glebe Point Road and Broadway to the former Grace Bros building (now the Broadway Shopping Centre). Most lots are currently occupied by one or more buildings on the site and vary greatly in their frontages to Broadway and their subsequent size.

The built form across the study area is typically composed of street wall buildings which range from two to four storeys in height. Their architectural language can best be described as varied, with architectural styles ranging from Victorian to Art Deco. A small portion of the western section of the study area is partially located within the Glebe Conservation area (see Section 1.8).

The northern boundary of the study area is bound by Grose Street, which is currently used as a service road by the adjacent Broadway Shopping Centre. Although the road provides vehicular access to the study area, the adjacent shopping centre loading dock is a major source of noise pollution.

Lot Ownership

Most lots within the study area are under individual ownership with the exception of 257-259 Broadway and 233-245 Broadway which are multiple lots under single ownership.

The development options in this report are based on some lot amalgamations, as explained in Section 3.1.

Current Planning Proposal Requests

There are current planning proposal requests for the development of 253 Broadway and 263-279 Broadway (see Section 1.2).



Key

- Study Area
- Lot Boundary (Separate Ownership)
- Lot Boundary (Combined Ownership)
- Planning Proposal requests

North Elevation - Broadway

STUDY AREA

2-12 Broadway (University Hall)

1-9 Glebe Point Road

279 Broadway

263-253 Broadway (Park View) Building

261 Broadway

257-259 Broadway

255 Broadway

247-253 Broadway

243-245 Broadway

233-241 Broadway

229-231 Broadway

225-227 Broadway

Broadway Shopping Centre

Uni Lodge Student Accommodation

University Hall
+38.14

255 Broadway
Parapet
+37.98

Broadway Shopping
Centre (Turret)
+39.13



Scale 1:1,000 @ A3



1.2 Current Planning Proposals

253 Broadway, Glebe

The indicative Concept Design by a+ Design Group for 253 Broadway was developed to support a request to prepare a Planning Proposal for the site which sought to amend the height and floor space ratio allocated for the site. Similar to adjacent sites, the subject site is zoned B2 (Local Centre). The Concept Design for the site proposed an increase in the maximum floor space ratio for the current site from 2.0:1 to 4.0:1. It was unclear in the concept from the drawings, the height of the proposed building.

The Concept Design retains the function of the existing building which is a hotel and retail use at ground floor. The hotel is currently housed in a poorly maintained period Art Deco building. The new design assumes the demolition of the existing building on site to make way for the new building. The Concept Design proposes a seven storey, 79 room hotel with a central atrium and rooftop bar.

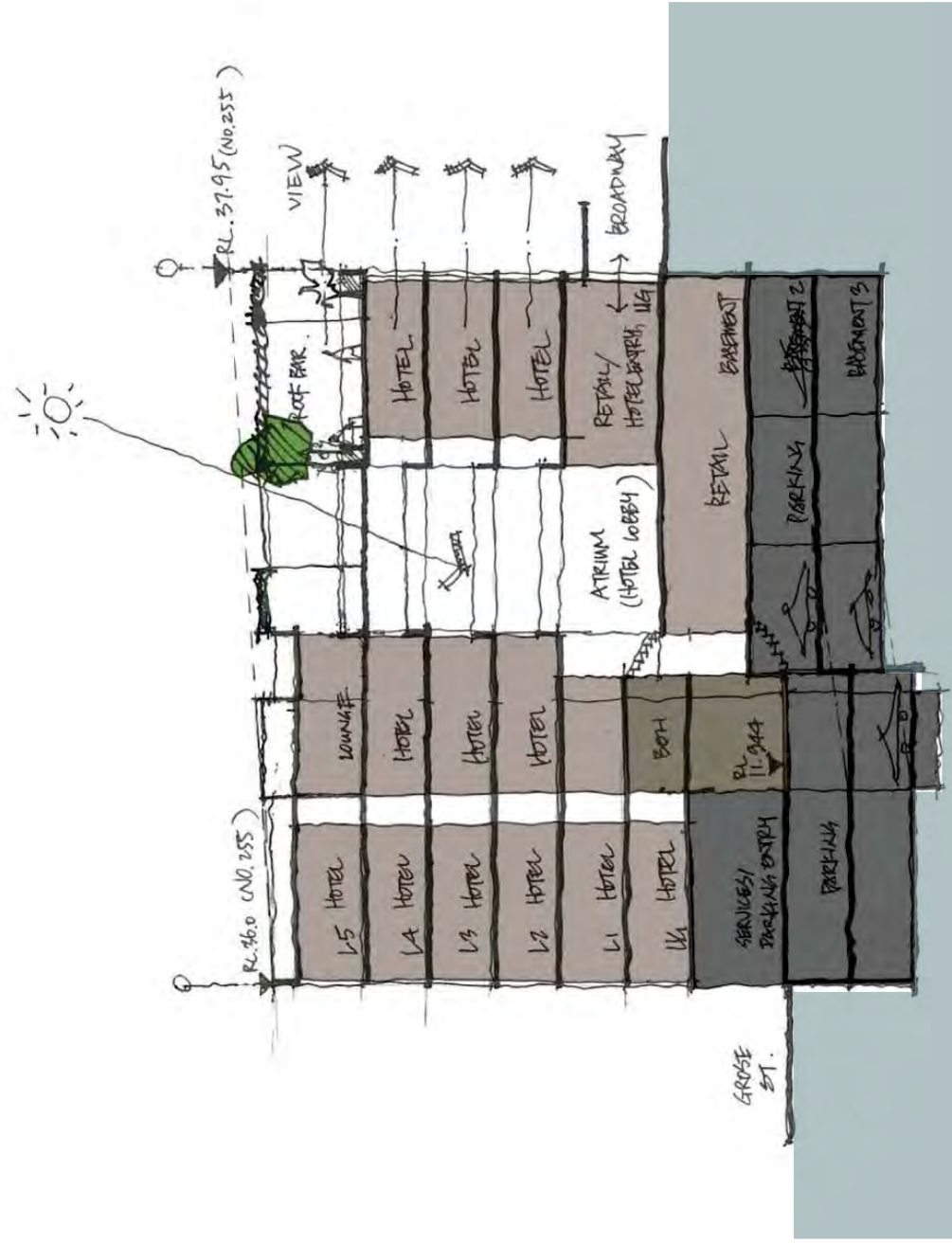
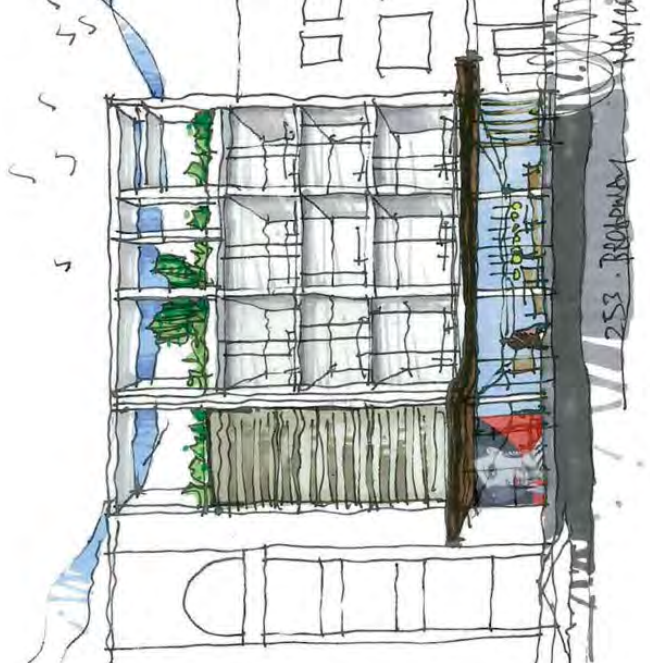

263-279 Broadway, Glebe

SJB Architects have undertaken an indicative design for a five (5) to six (6) storey mixed use development as part of a request for a Planning Proposal for the site. The new building proposes the demolition of all buildings on site, replacing them with a single building.

The request for a Planning Proposal seeks to increase the maximum floor space ratio for the current site from 2.0:1 to 3.5:1 (mixed use commercial and residential use) or 4.5:1 (mixed use retail and residential use). The Proposal also seeks an amendment to the prescribed building height from 18.0m to 27.0m when measured from Grose Street

The indicative design features a partial retail level on ground floor to the Broadway frontage and a central courtyard above ground where apartments or commercial floor space are arranged. The site is currently zoned under B2 Local Centre.

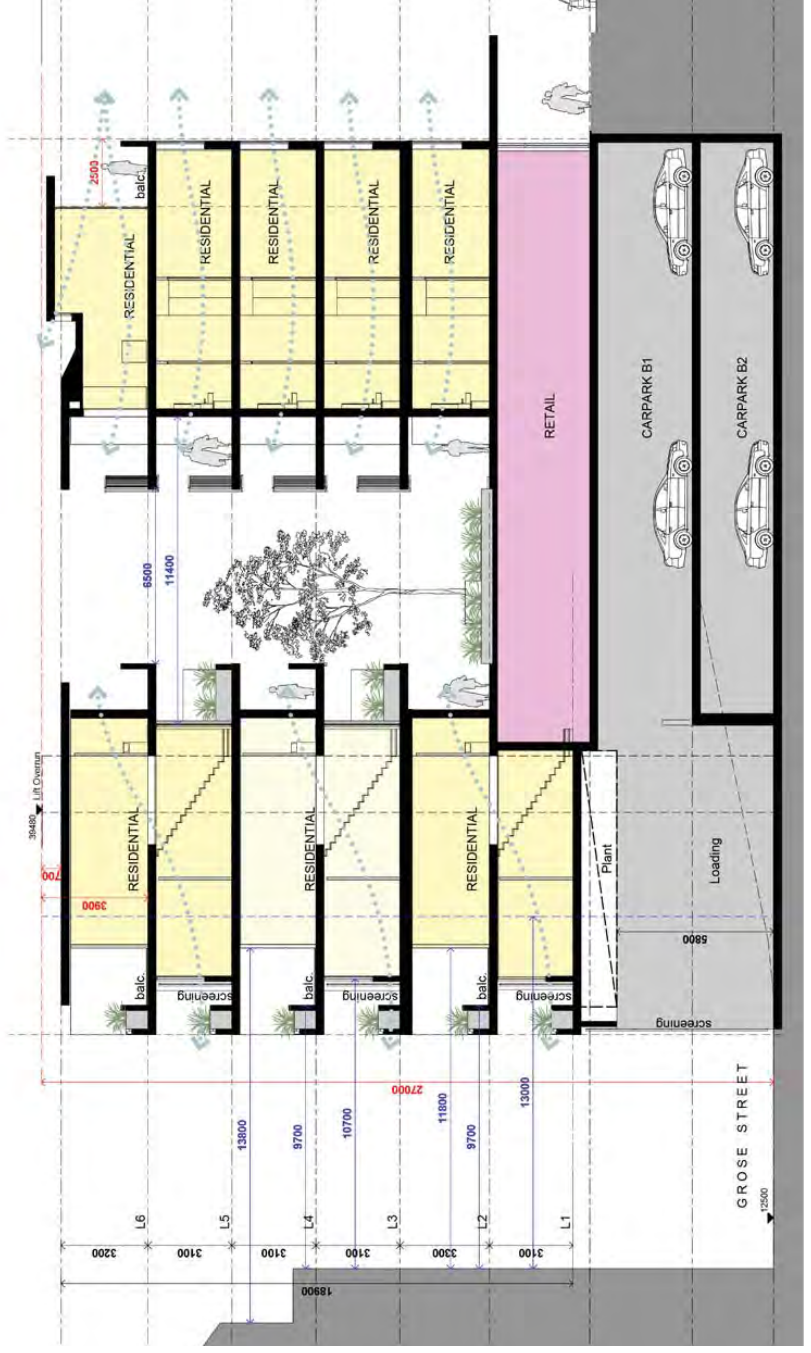

1.3 Precinct Character and Context

Study Area

The existing study area is made up of 14 individual lots and stretches from the corner of Glebe Point Road and Broadway to the former Grace Bros building (now the Broadway Shopping Centre). Most lots are currently occupied by one or more buildings on the site and vary greatly in their frontages to Broadway and their subsequent size.

The built form across the Study Area typically composed of street wall buildings which range from two to four storeys in height. Their architectural language can best be described as varied, with architectural styles ranging from Victorian to Art Deco. A small portion of the western section of the study area is partially located within the Glebe Conservation area (see Section 3.1)

The northern boundary of the study area is bound by Grose Street, which is currently used as a service road by the adjacent Broadway Shopping Centre. Although the road provides vehicular access to the study area, the adjacent shopping centre loading dock is a major source of noise pollution.



View from Broadway looking south to the intersection of Glebe Point Road



View from Broadway looking south to the intersection of City Road

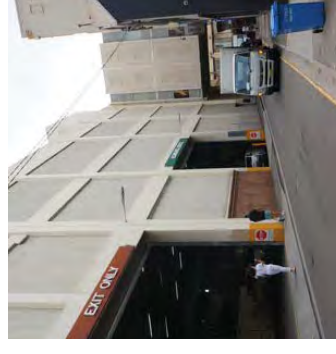

View from Grose Street of loading dock, to Broadway Shopping Centre



Commercial building at 4-8 Grose Street



View from Grose Street of vehicular entry to 255 Broadway



Buildings at 255 Broadway (APCS) and 265 Broadway (Art Deco Hotel), potential heritage items

Broadway

Broadway is a locality around the road of the same name, which borders the suburbs of Ultimo, Chippendale and Glebe. The road is historically significant as it is one of the first roads built in New South Wales, connected George Street and Parramatta Roads. Broadway is lined by a number of heritage buildings on both sides ranging for 2 to 5 storeys in height and marked by a number of infill buildings

The stretch was also a hub for major retailers in the early 20th century and previously home to the Grace Brothers department store (now the Broadway Shopping Centre).

A number of educational institutions are located along or around Broadway, including the University of Technology, Sydney Institute of Technology and Notre Dame University.

More recently an increased demand for housing close to the city along with the development of University sites along Broadway has seen a dramatic change in the road's built form character. The most visible of these changes can be seen at the eastern end of Broadway. The One Central Park building on the former CUB site and the UTS Building 9 both rise to meet the previously constructed UTS tower to reinforce Broadway as a 'gateway' into central Sydney.



Village character - view looking north east down Glebe Point Road



Village character - view looking north east down Glebe Point Road

City Road

City Road is a major road located off the corner of Broadway and Parramatta Road. The road extends from north to south, along Victoria Park through to the University of Sydney and becomes King Street as it enters the suburb of Newtown.

The road previously was served by the Sydney Tram service until its removal in the 1950's and was replaced by the bus services, all of which still run today. For the most part, the road forms the suburban boundary between Chippendale and Victoria Park.

The scale of development to the Chippendale edge of City Road is relatively low density, characterised by terrace houses and small scale shops.

The northern end to City Road is framed by the prominent clock towers of the Broadway Shopping Centre and marks the intersection of the road to Broadway.



Fine grain street edge development to City Road



View from City Road looking north to the intersection of Broadway (Victoria Park to the left)



Victoria Park edge to City Road

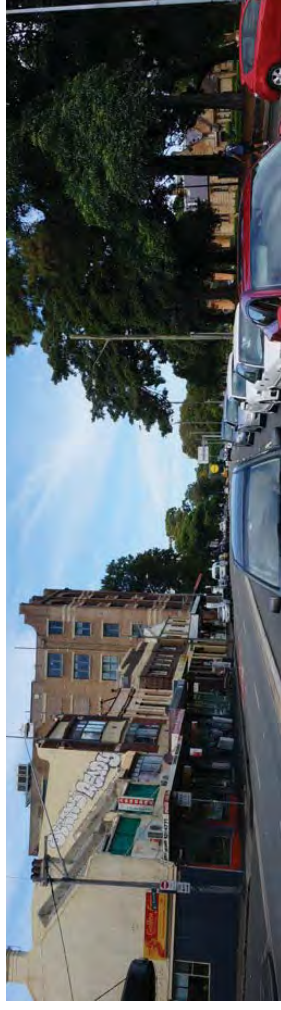

View from City Road looking south - west to the University of Sydney

Glebe

Glebe is a suburb which is surrounded by Blackwattle and Rozelle Bays, inlets of Sydney Harbour, in the north. The suburb consists of a diverse mix of single dwellings, terraces, apartments and public housing estates.

It is a culturally vibrant community and home to a diverse mix of residents which include young families, university students and young professionals. While the suburb has undergone a gradual gentrification over a period of time, a large proportion of residents live in public housing estates to the south-eastern end of the suburb.

Glebe is well served by public infrastructure. Its high street, Glebe Point Road is served by buses that run regularly to central Sydney. It is also served by two local light rail stations and several public schools are located within the area.



Department of Housing development from the 1980's



Terrace house development typical to Glebe

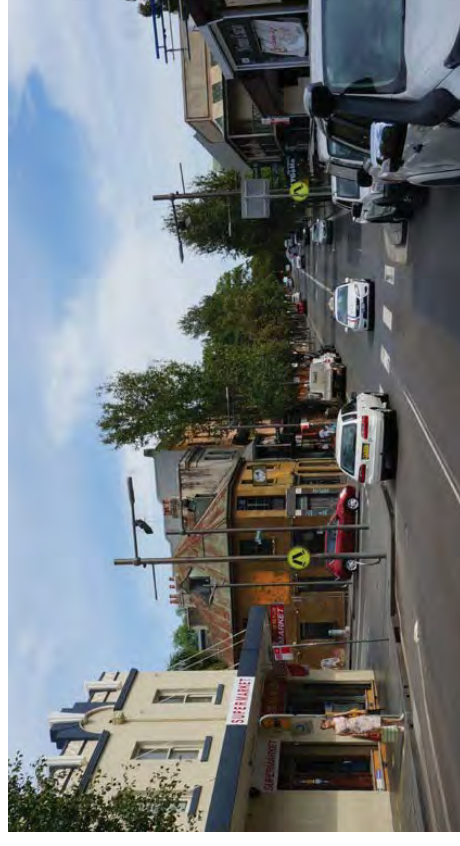

Village character - view looking north east down Glebe Point Road conservation area

Glebe Point Road

The Glebe Point Road is the main road of the inner city suburb of Glebe. The road begins at the north-eastern corner of Victoria Park, where Broadway becomes Parramatta Road.

The street is characterised by a series of low rise Victorian Federation shops and terrace houses which gives the street a village feel. It is protected by the Glebe Point Road Heritage Conservation Area listing.

The street is known as a boutique shopping strip famous for its numerous restaurants, cafés and bars. It is a destination for many in Sydney, with Glebe Point Road being seen as critical to a vibrant village atmosphere.

Glebe Point Road is also a significant transport corridor for the local area, connecting Glebe and surrounding areas to the Broadway Shopping Centre to Rozelle Bay to Alexandria, Coogee and the city centre.



View from Broadway looking south to the intersection of Glebe Point Road



Village character - view down Glebe Point Road conservation area featuring 2-3 storey retail shops

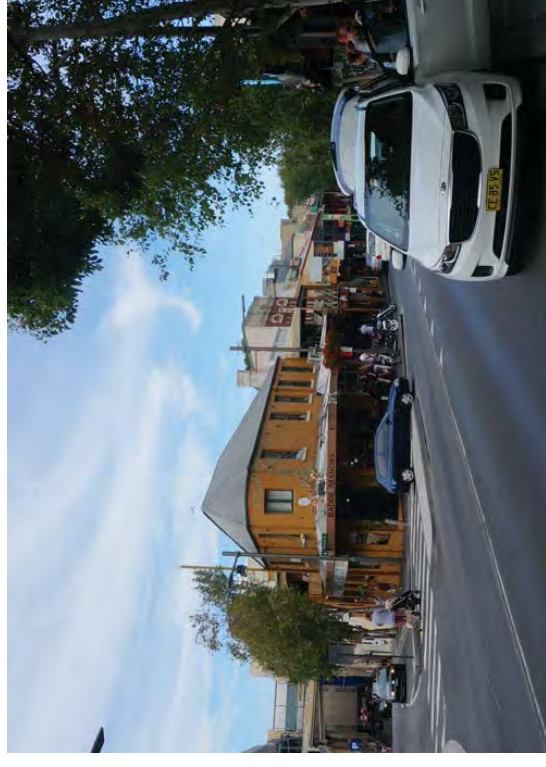

View from the intersection of Glebe Point Road and Francis Street

Ultimo

Ultimo is located 2 kilometres south-west of the Sydney central business district and is bound by Glebe to the west, Chippendale to the south and Pyrmont to the north.

The suburb was previously known as a centre for industrial activity within the city with its close proximity to the former working wharfs of Darling Harbour providing worker housing and storage facilities for goods. As a result, Ultimo is composed of a rich mix of masonry large industrial warehouse buildings of various styles and smaller terrace row houses.

In more recent history, the neighbourhood has undergone gradual gentrification with considerable redevelopment of former industrial buildings for both residential and commercial uses. Examples of this include the Broadway Shopping Centre, former home of the Grace Brothers department store.

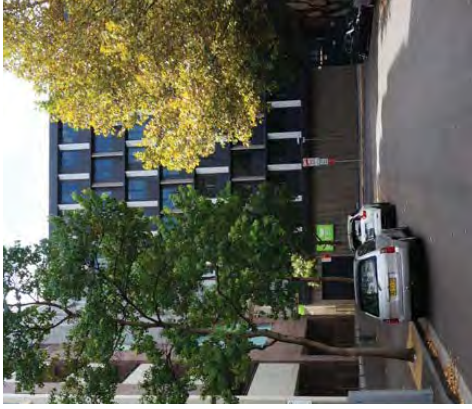

View from Small Street - new student housing development



View looking north down Mountain Street



View looking west from Kelly Street warehouse conversion - typical to area

Chippendale

Chippendale is located between Broadway to the north and Cleveland Street to the south, Central railway station to the east and the University of Sydney to the west. The suburb is one of the smallest in metropolitan Sydney and is characterised by a mix of tightly knit residential terrace houses, and multi-storey brick industrial buildings. Its narrow street network and relative lack of open green space creates a hard edged urban environment in which to work and live.

The western flank of Chippendale is largely residential with businesses interspersed in some parts of the precinct. More recently with the development of the Central Park precinct, Chippendale has seen a drastic and rapid transformation. Once a largely neglected part of the inner city, the suburb is now undergoing rapid gentrification and is the new focus for a rapidly growing arts and food culture within Sydney.

The University of Notre Dame Australia sits along the northern border with campus buildings scattered through the suburb. The University of Technology, Sydney and the University of Sydney have campuses nearby.



View from Shepherd Street - warehouse and terrace house typologies



View from Buckland Street and Blackfrans UTS Campus (left)

Victoria Park

Victoria Park is situated on the corner of Broadway and City Roads, adjacent to the grounds of University of Sydney and across Parramatta Road from the area of study.

The nine hectare park is used regularly by residents as a place of gathering on occasion and for recreational uses. It is characterised by large grassy fields criss crossed by a number of pathway networks that lead to and from the Sydney University grounds. A number of mature trees are located in and around the park grounds along with a small picturesque lake (Lake Northam). A swimming pool complex is also located within the parkland which is used regularly by local residents.

The park also contains a number of historic structures that provide a reference to the park's heritage. These include the entrance gates on Parramatta Road and the Gardener's Lodge off City Road (which has now been adapted to house a café). These and other items within the parkland are heritage-listed along with the University and its grounds.

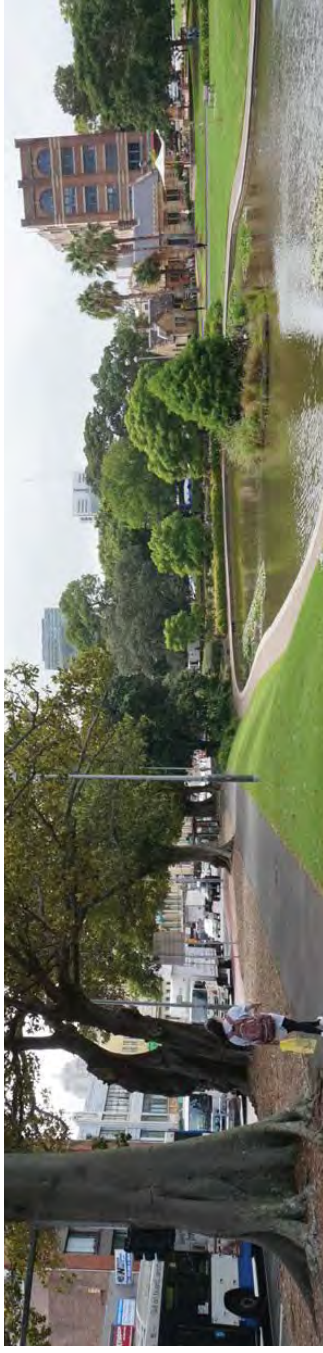

View of Victoria Park looking east from Broadway



View of study area looking from Victoria Park



View of study area looking from Victoria Park across Lake Northam



Heritage Item - The Gardener's Lodge



View of ceremonial axis from Sydney University Grounds to city centre

1.4 Land Use

The Broadway precinct is characterised by a variety of uses which range from education and recreation to retail and residential. The subject site is flanked by Broadway Shopping Centre to the north and Victoria Park to the south. The surrounding suburbs of Chippendale and Glebe are primarily low density residential areas with a mix of traditional Victorian terrace houses, adaptive re-use buildings and infill housing. A number of educational institutions line Broadway including the University of Technology and the University of Notre Dame along with a large number of small retail shops and restaurants.

The Broadway shopping centre is composed of two large singular buildings which occupy two entire blocks to the north of the site and are up to six storeys in height. The shopping centre itself is designed to be inward looking and is devoid of external windows or openings. With the exception of car park and loading entries at street level, the centre does little to respond and engage with its immediate context.

Victoria Park, located to the south of the site, provides local residents, students and visitors with a large, open green space and additional facilities such as the Victoria Park pool and gym. The site provides expansive views of the park and Sydney University beyond.

While the site is located partially within a Heritage Conservation area, no heritage buildings are currently identified on site. A number of heritage listed items are located nearby including the former Grace Bros. Building (currently part of Broadway Shopping Centre) which is located on the eastern boundary of the site.

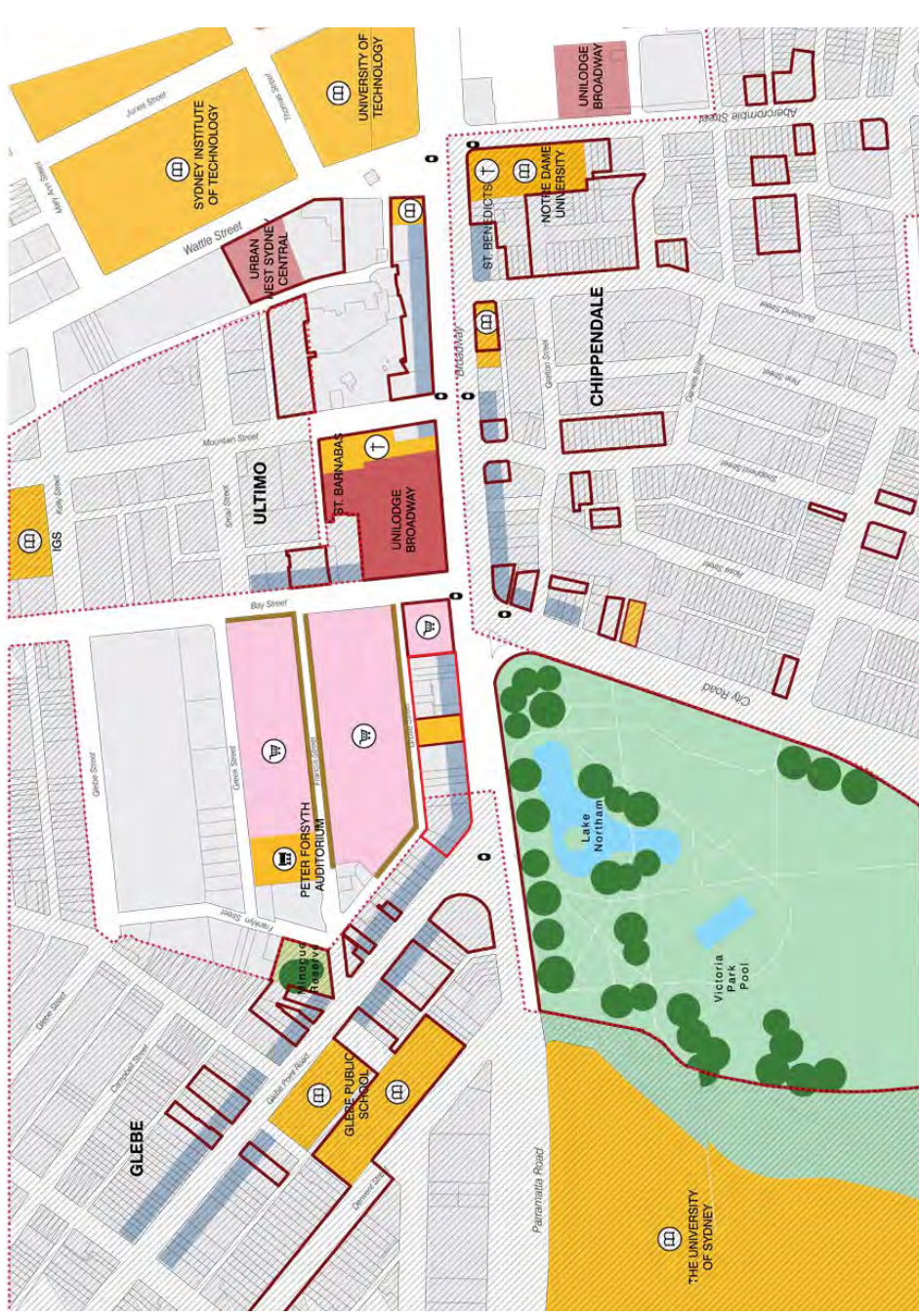

Land Use and Character

1.5 Access and Connectivity

The subject site is located on Broadway (a major arterial road connecting Sydney with Parramatta) which offers good connectivity for both public and private transport options. Bus stops are located on Broadway, Glebe Point Road and City Road providing direct access to the City as well as Sydney's western and south-western suburbs.

The site is also served by Grose Street which is a one way street located on the northern boundary, adjacent to the Broadway Shopping Centre. Grose street lacks amenity and is used primarily as a service road to access parking for existing uses as well as the shopping centre loading docks and car park.

Broadway experiences a high volume of foot traffic as it is the main road connecting Sydney University, UTS and the University of Notre Dame and its proximity to Broadway Shopping Centre. Pedestrian crossings along Broadway are located at the intersections to Glebe Point, City Rd, Mountain and Abercrombie Streets.

There are no dedicated cycleways adjacent to the site although Glebe Point Road is classified as being 'bicycle-friendly'.

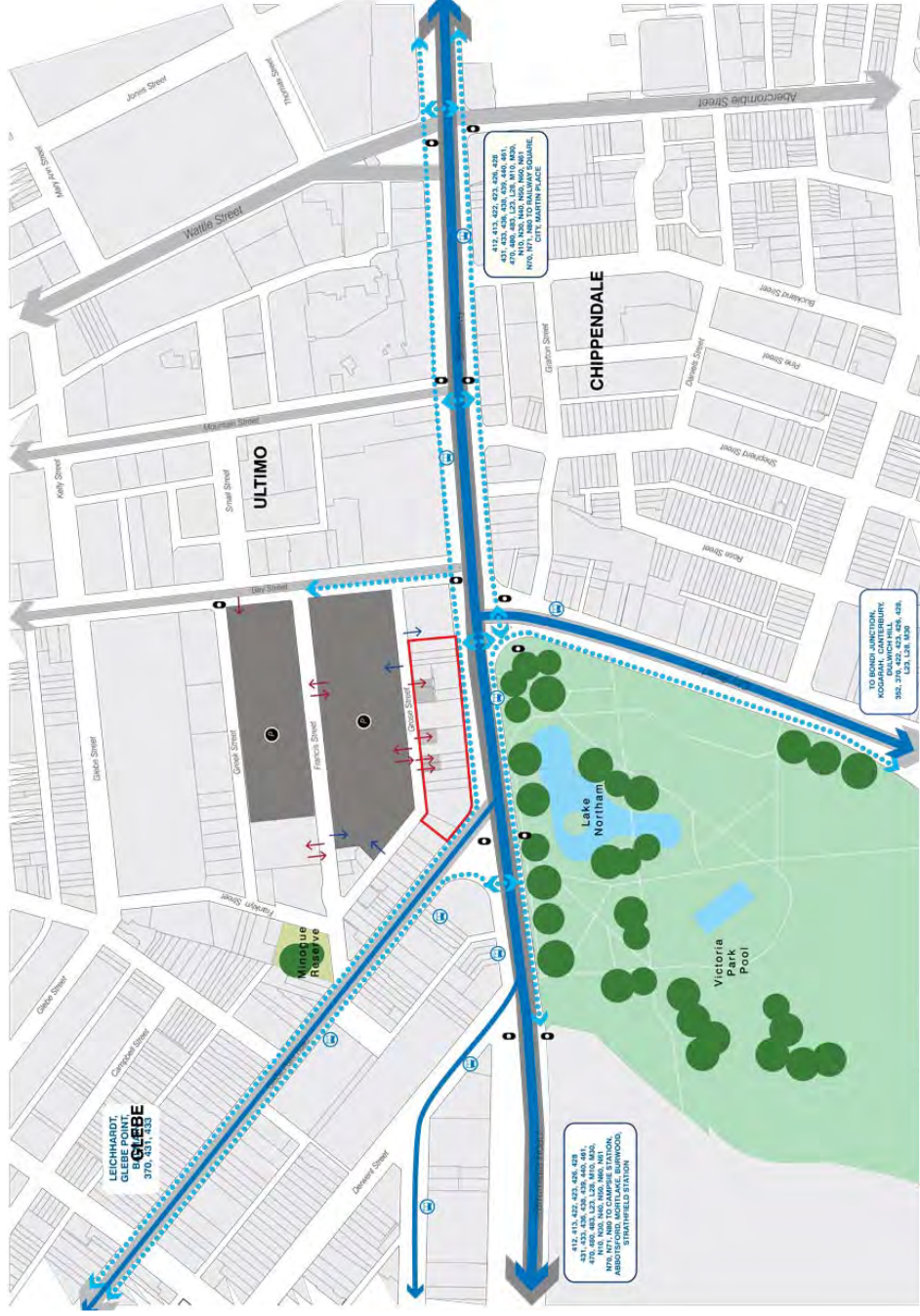

Vehicular and Pedestrian Connectivity on Broadway



1.6 Figure Ground

The figure ground diagram clearly shows the density of development in and around the study area. The study area itself is shown to be heavily developed with only a small portion of unoccupied open space.

To the north of the site, the Broadway Shopping Centre is a dominant feature on the landscape. All of the buildings have a footprint equivalent to the site and provides little or no permeability between blocks.

Beyond the immediate study area, the built form along Glebe Point Road generally appears finer and more permeable than the buildings on Broadway.

In the street blocks to the east of the study area, the northern edge of Broadway is defined by a continuous street wall built form that is broken only by the north-south streets.

By contrast, the southern side of Broadway is generally composed of much smaller lots and finer scale built form which includes the St. Benedict's church grounds.



Key

- Study Area
- Public Open Space
- Private Open Space
- Built Form

Figure Ground

Scale 1:2,500 @ A3

1.7 Building Height

The building height mapping diagram clearly shows the density of development in and around the study area. The study area itself is shown to be composed of two to four storey buildings which vary in scale and height.

Immediately north of the study area, the Broadway Shopping Centre features prominently standing at a height of 5-7 storeys across two blocks to the north of the study area.

Beyond the immediate study area, the built form along Glebe Point Road generally feature a uniform 2-3 storey terrace style buildings with awnings and balconies fronting the street.

In the street blocks to the east of the study area, the northern edge of Broadway is characterised by buildings which are 3 storeys and above. The tallest built form, at 8 storeys is set back from the street.

By contrast, the southern side of Broadway is generally composed of much smaller lots and finer scale built form which includes the St. Benedict's church grounds



Key

- Study Area
- Public Open Space
- Private Open Space
- 1 Storey
- 2 Storeys
- 3 Storeys
- 4 Storeys
- 5-7 Storeys
- 8+ Storeys

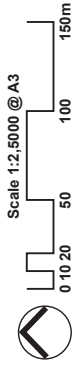

Building Height

1.8 Development Controls Summary

Sydney Local Environment Plan (LEP) 2012 Planning Instruments

Land Zoning

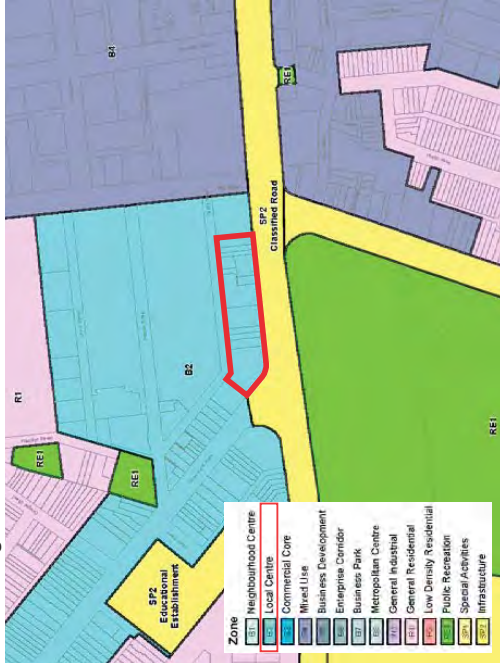

All lots within the study area are located in Zone B2 Local Centre. The objectives of this zone aim to provide a variety of retail, business, entertainment and community uses to support people who live in, work and visit the area. Other key objectives of the zone include encouraging accessible employment opportunities, active transport participation maximising public transport patronage, and facilitating appropriate residential uses that support the vitality of the local centre, in this case being Glebe.

Permissible land uses in the B2 zone allow for child care and medical centres, commercial premises, community, educational and entertainment facilities, in addition to tourist and visitor accommodation and shop top housing.

Floor Space Ratio



The study area is subject to a maximum Floor Space Ratio control of 2:1. This density supports a gradual transition from the built environment and open space; from 2.5:1 to the north and east side of the site, to 1.5:1 to the north-west of the site along Glebe Point Road and to the south to Victoria Park.

Height of Buildings



The objective of the height of building control is to ensure the height of development is appropriate to the site and context. The maximum height control of the site ensures appropriate height transitions between new development and existing heritage items and buildings in heritage conservation areas, promote the sharing of views.

An 18m maximum building height limit applies to all lots in the subject site. This corresponds with other properties along the north side of Broadway. A 15m height limit applies to the shopping centre north of the site, while a series of height limit transitions (15m and then 12m) step down from Broadway to a uniform 9m maximum building height along Glebe Point Road.

The height controls of the site ensure future built form complements existing heritage buildings, is of a scale that supports the vibrant mix of uses and passive surveillance along Glebe Point Road, in addition to minimising adverse overshadowing impacts on the street and adjacent Victoria Park.

Heritage



None of the lots within this subject site are heritage items, however there are heritage issues to consider for some of these properties.

To the south side of Broadway is the Local Heritage listed Victoria Park. Future developments of the site will need to consider the impact of the proposed development on these items, as well as other heritage items in the vicinity.

Adjacent to the east end of the subject site is the Local Heritage listed former Grace Bros department store (213 Broadway). To the west of the site, opposite Glebe Point Road, is the State Heritage listed University Hall and Colleges building (281-285 Broadway, Glebe).

The site at the corner of Broadway and Glebe Point Road (263-279 Broadway) is located within a Heritage Conservation Area, and as such, future development must be considered against the specific characteristics of this Heritage Conservation Area. (The Building Heritage Contribution, from the Sydney Development Control Plan 2012, is explained on the following page).

Public Transport Accessibility Level

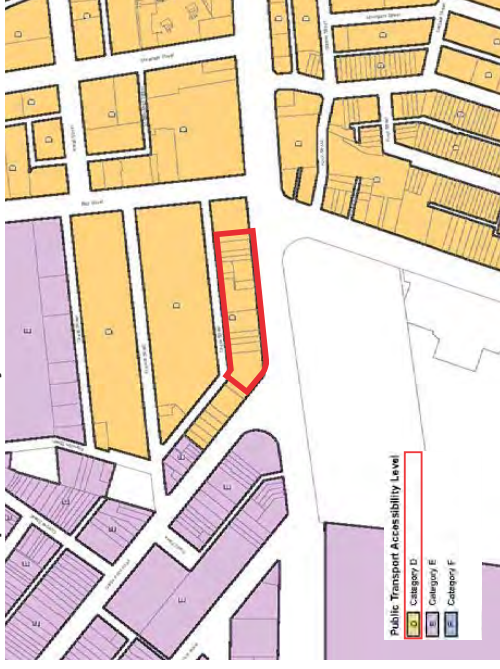

The subject site is listed as Category A under the Land Use and Transport Integration plan, and Category D under the Public Transport Accessibility Level plan. This means that the site has the highest level of transport accessibility available, and therefore is subject to more restrictive car parking controls relative to other sites located further away from public transport services.

Land Use and Transport Integration



Sydney Development Control Plan (DCP) 2012

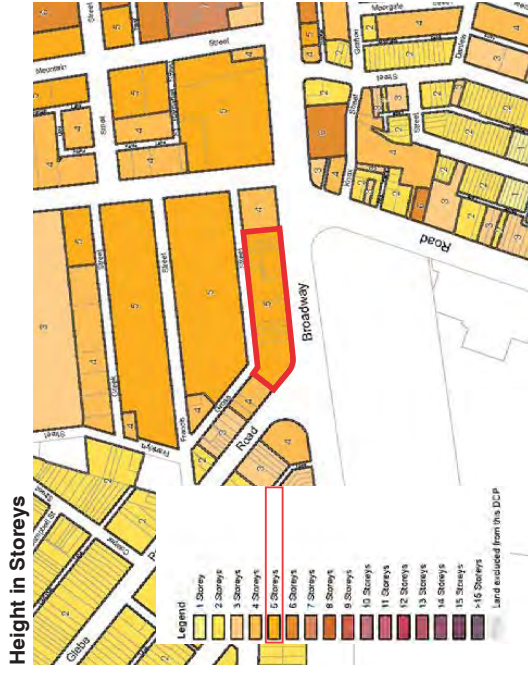

The Sydney DCP 2012 provides a five storey height control for all lots within the subject site. This is compatible with the 18m height limit as prescribed by the Sydney LEP 2012.

Sunlight to Publicly Accessible Spaces

The study area is elongated in an east-west direction, and is located to the north of Victoria Park. Any development of this site must minimise overshadowing of this publicly accessible space.

Section 3.2.1.1 of the DCP on 'Sunlight to Publicly Accessible Spaces' requires:

- (1) Overshadowing effects of new buildings on publicly accessible open space are to be minimised between the hours of 9am and 3pm on 21 June
- (2) Shadow diagrams are to be submitted with the development application and indicate the existing condition and proposed shadows at 9am, 12 noon and 2pm on 14 April and 21 Jun. If required, the consent authority may request additional detail and assess the overshadowing impacts.

Active Frontages

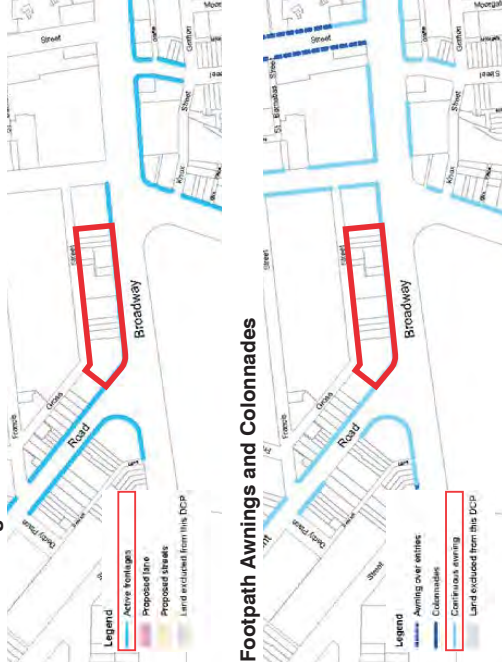

Active Frontages:

An active frontage is to be provided along the southern boundary of all lots in the study area. This will contribute to the continuous active frontage proposed along Broadway and Glebe Point Road between Bay Street and Francis Street.

Footpath Awnnings and Colonnades:

A continuous awning is to be provided above the footpath to shelter pedestrians and support activity along the Broadway and Glebe Point Road frontages of this site.

Pedestrian Priority

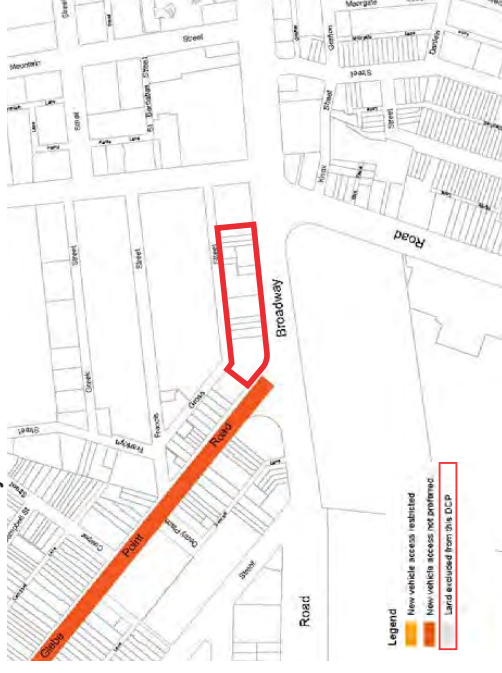

Glebe Point Road is identified as a pedestrian priority street. The study area's frontage to Glebe Point Road and Broadway has a significant role to play in supporting or enhancing the vibrancy of street life as well as connecting pedestrians in Glebe Point Road with transport, shopping, employment, and recreation opportunities in Broadway, Ultimo, Victoria Park, and Chippendale. Vehicle movements generated by the subject site should be directed away from Glebe Point Road to discourage increased vehicular access to this people-oriented place.

Late Night Trading Areas



The subject site is part of the Broadway-centred "City Living Area", a place with an evolving consideration for night time entertainment. This may involve considerations for the management and trading hours of night time activities on the site.

Building Heritage Contribution

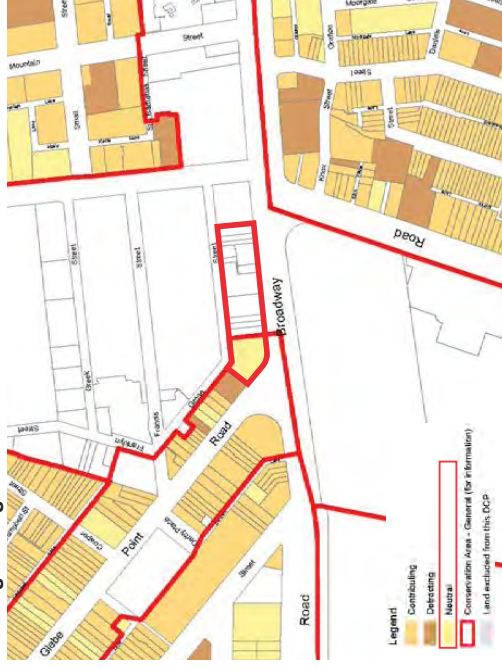

The subject site has been assessed for its contribution to heritage areas, and 263-279 Broadway has been determined as providing a neutral effect on the heritage sites on Glebe Point Road. Should this site redevelop, its contribution should either be enhanced to "contributory" or remain neutral – it should not detract from the special characteristics of the Heritage Conservation Area.

Local Character Areas

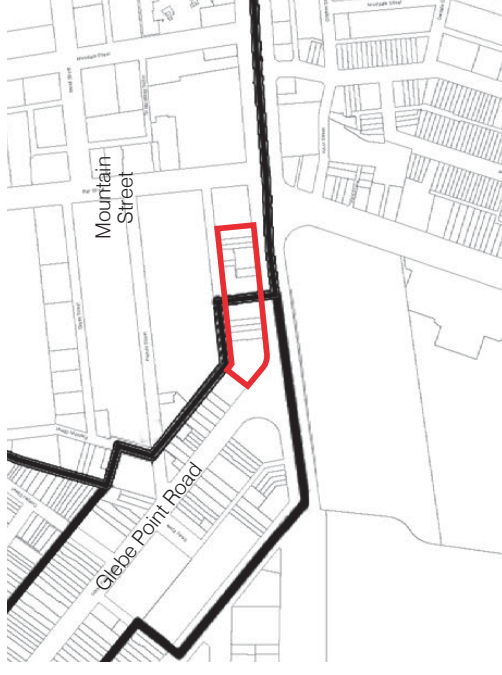

The site is subject to two local character areas – Glebe Point Road and Mountain Street.

Glebe Point Road

Glebe Point Road is encouraged to develop as a focus for cultural, artistic, health and well-being uses. Thus development is to be consistent with 19th Century streetscape consisting of fine grain small scale, 2-3 storey buildings, supporting diverse and vibrant uses. Pedestrian focussed interfaces and considered street plantings are important.

Mountain Street

The area is to continue to provide a diverse and sustainable mix of uses in adaptively reused warehouse buildings or in new buildings at bulk and scale complementary to existing. Views through the precinct to Wentworth Park are to be retained and access to open space improved.

1.9 Heritage

Heritage Considerations

The study site is bookended by the former Grace Bros. Building (Broadway Shopping Centre) located on the eastern boundary and the Glebe Point Road Heritage Conservation Area on the western boundary. The western edge of the study area is part of the Glebe Point Road conservation area.

Within the study area itself, the heritage report undertaken by heritage consultants RPS, following advice from the City of Sydney, considers each lot's contribution to heritage attributes of the area – specifically to the Glebe Point Road Heritage Conservation Area at the western end of the study site, and more generally in close proximity to other City of Sydney Heritage Conservation Areas.

The heritage report also identifies a number of properties within the study area as having a 'contributory' value to the heritage value of Broadway. These potentially include 4-8 Grose Street, 225-227, 247-253, 255, 261 and 263 Broadway.

The subsequent development options in this report (in particular option 1) has been adapted to reflect an outcome where a partial retention of these buildings has been explored.

Heritage Contribution Assessment

Address	Potential Contribution to Streetscape	Description
279 Broadway	Contributory	Federation freestyle design with prominent archway and articulated parapet
263-277 Broadway	Neutral	Ca. 1939-41 inter-war functionalist building with restrained detailing and curved frontage addressing the Glebe Point Road corner.
263 Broadway	Contributory	Early 20th Century Federation Anglo-Dutch style with attractive Dutch gable.
261 Broadway	Contributory	Early 20th Century Federation freestyle classical styling with prominent banded pilasters.
257-259 Broadway	Neutral	Estimated late Victorian / early Federation building with classical window proportions and dressed sandstone frontage to Grose Street.
255 Broadway	Contributory	Large Federation warehouse featuring a distinctive arched facade with dressed sandstone detailing.
247-253 Broadway	Contributory	Inter-war Art Deco building with horizontal articulation and prominent stepped bay feature.
243-245 Broadway	Neutral	Inter-war building with limited architectural significance.
233-241 Broadway	Neutral	Inter-war building with limited architectural significance.
229-231 Broadway	Neutral	Estimated Victorian buildings with moulded parapet and pediment details.
225-227 Broadway	Contributory	Double bay terrace Ca. 1886 with highly modelled facade, classically detailed window surrounds, and strong course and parapet detailing.
4-8 Grose Street	Contributory	Estimated mid 19th Century / early Victorian / old Colonial building of restrained form and scale.



1.10 Noise

Noise Considerations

The study area is exposed to major sources of noise along its two major elevations - Grose Street to the north and Broadway to the south. The acoustic assessment undertaken by Acoustic Logic presents a summary of existing conditions on site and a review of potential natural ventilation measures that minimise the impact of road traffic noise in residential development.

The report took into consideration the following measures to maximise the performance of the proposed built form envelopes within the study area. These measures included:

- Built form configuration - perimeter block buildings with operable fenestration facing into central courtyards and street setbacks (to option 1 only).
- Internal apartment layout and orientation
- Acoustically treated winter gardens was possible to alleviate road noise to Broadway, however this potentially would add significant cost to a residential development and may significantly dictate the aesthetic of the building.
- Acoustically treated bulkheads and ventilators.

While these measures assisted in the mitigation of noise it was noted that no single solution could alleviate noise to within acceptable levels as outlined in the report. A combination of these measures could be implemented to provide an acceptable acoustic outcome.

Following a further investigation of the built form envelopes, the following key recommendations were made for development sites tested:

- Adopting a perimeter building typology with a central courtyard.
- Orientating all habitable rooms and operable fenestration in apartments inwards to address the central courtyard and to provide natural ventilation.
- Placing all circulation spaces including lifts, lobbies and corridors to the outer perimeter of the building adjacent to major roads.
- Restricting the height of proposed buildings on Grose Street such that it does not exceed that of Broadway, allowing for one building to shield the other.

The report also noted that for all scenarios, the noise from the mechanical plant from the Broadway Shopping Centre on Grose Street will need to be addressed given its immediate impact to the north façades of the study area. This may be addressed through the application of acoustic attenuation. The report noted that this process would require negotiation with the appropriate land holders which may or may not be proven not be proven feasible.

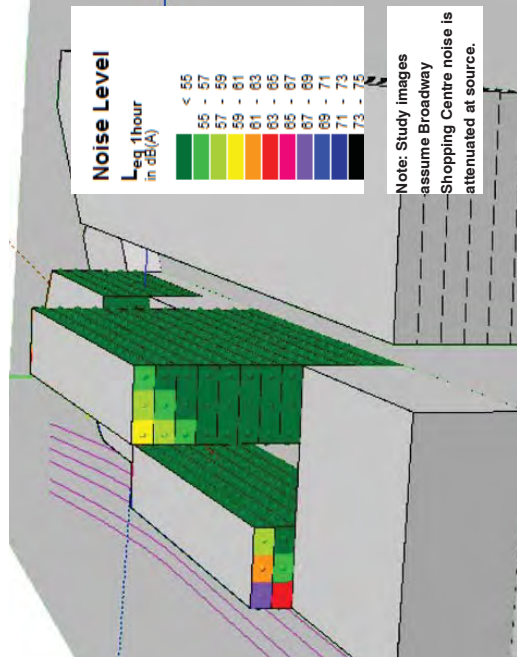
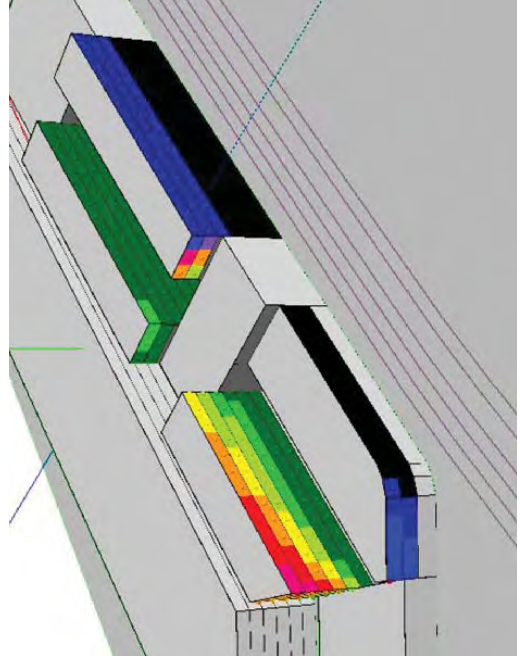
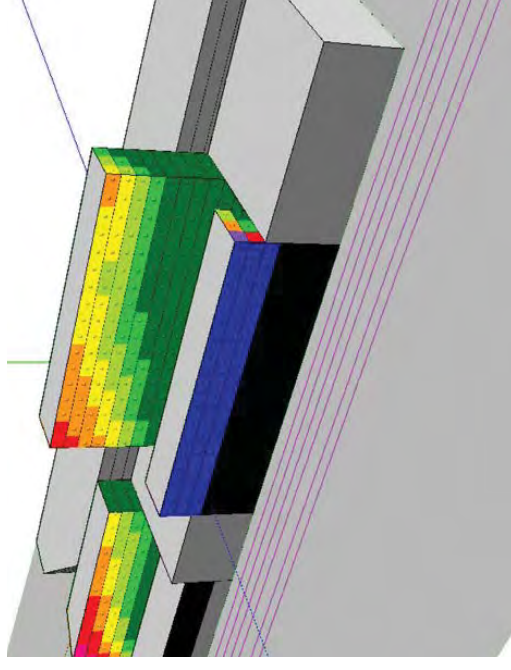

1.11 Broadway Building Datums

Broadway - North Elevation

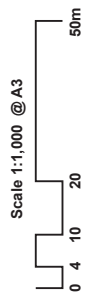
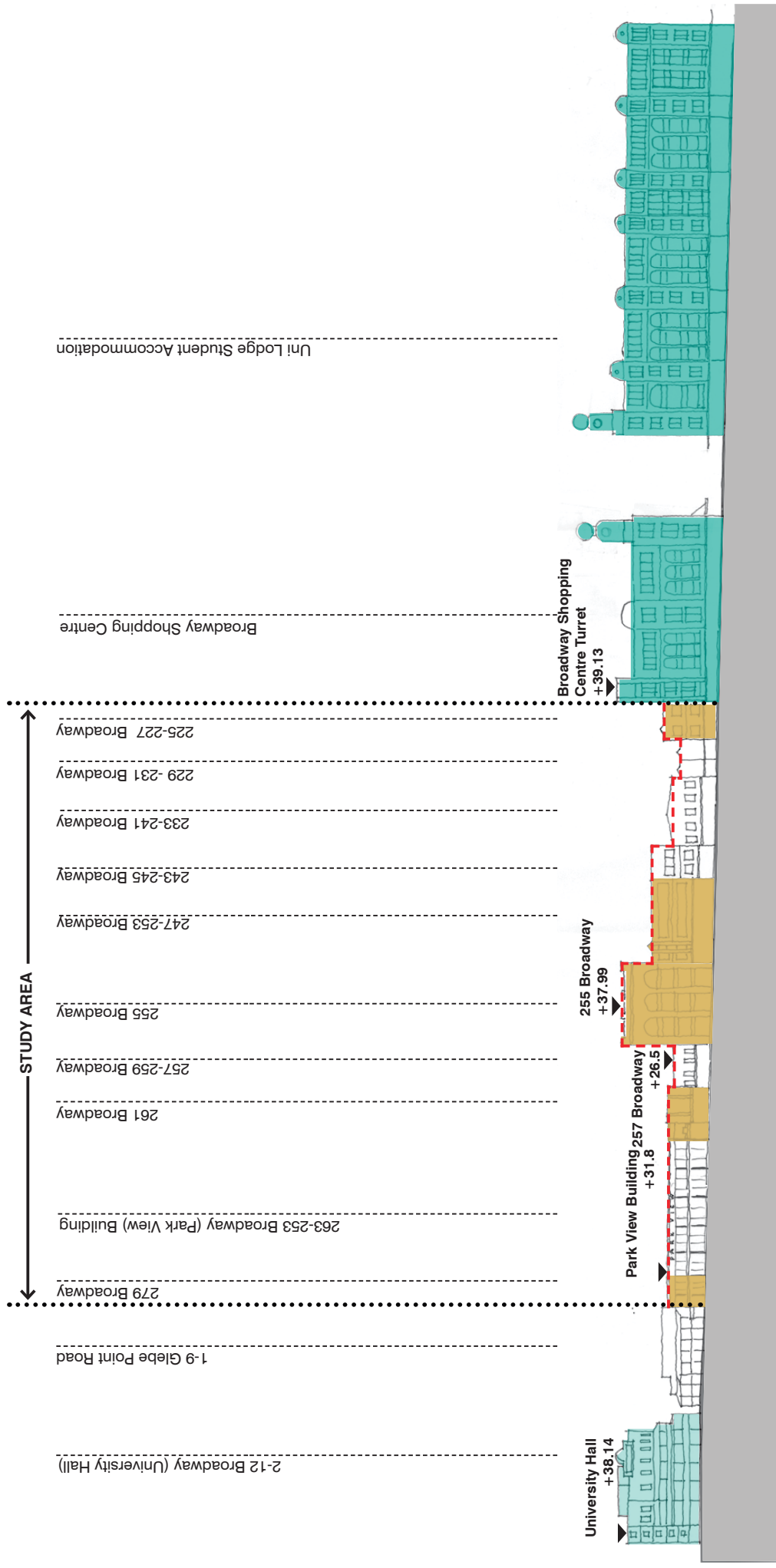

1.12 Study Area Existing Built Form



1.13 Opportunities and Constraints

Opportunities

- 1 The site has a clear and unobstructed view to Victoria Park and Sydney University precinct.
- 2 Close proximity to major education institutions including – Sydney University, UTS, Notre Dame University + Sydney Institute of Technology.
- 3 Broadway provides potential for a highly visible and active frontage. The road is a major arterial which carries high volumes of both vehicular and pedestrian traffic.
- 4 The intersection of Broadway and Glebe Point Road is a significant ceremonial gateway marking the entry into the suburb of Glebe.
- 5 The site has good access to city views above the Broadway Shopping Centre.

Constraints

- 6 The diversity of lot sizes across the site may affect permeability and result in inconsistent development along the street over time as smaller sites are unlikely to develop for non-residential uses.
- 7 Heritage buildings within the immediate vicinity of the site including University House and Grace Bros. Building provide a pre-established datum for potential podium development.
- 8 Grose Street is largely neglected and used as a service road for the adjacent Broadway Shopping Centre's loading docks.
- 9 The Broadway Shopping Centre's current building height (six storeys) limits solar access to the site. The plant rooms located on the centre's roof is also a major source of noise pollution on site.
- 10 Vehicular traffic along Broadway is a major source of noise and emissions pollution.
- 11 Any future development above the existing line of buildings may cause overshadowing to Victoria Park.
- 12 Any new development will need to ensure the preservation of existing views across the site from Victoria Park to Sydney CBD.
- 13 Existing buildings currently within the study area that have Heritage significance will need to be considered when looking at re-development options.

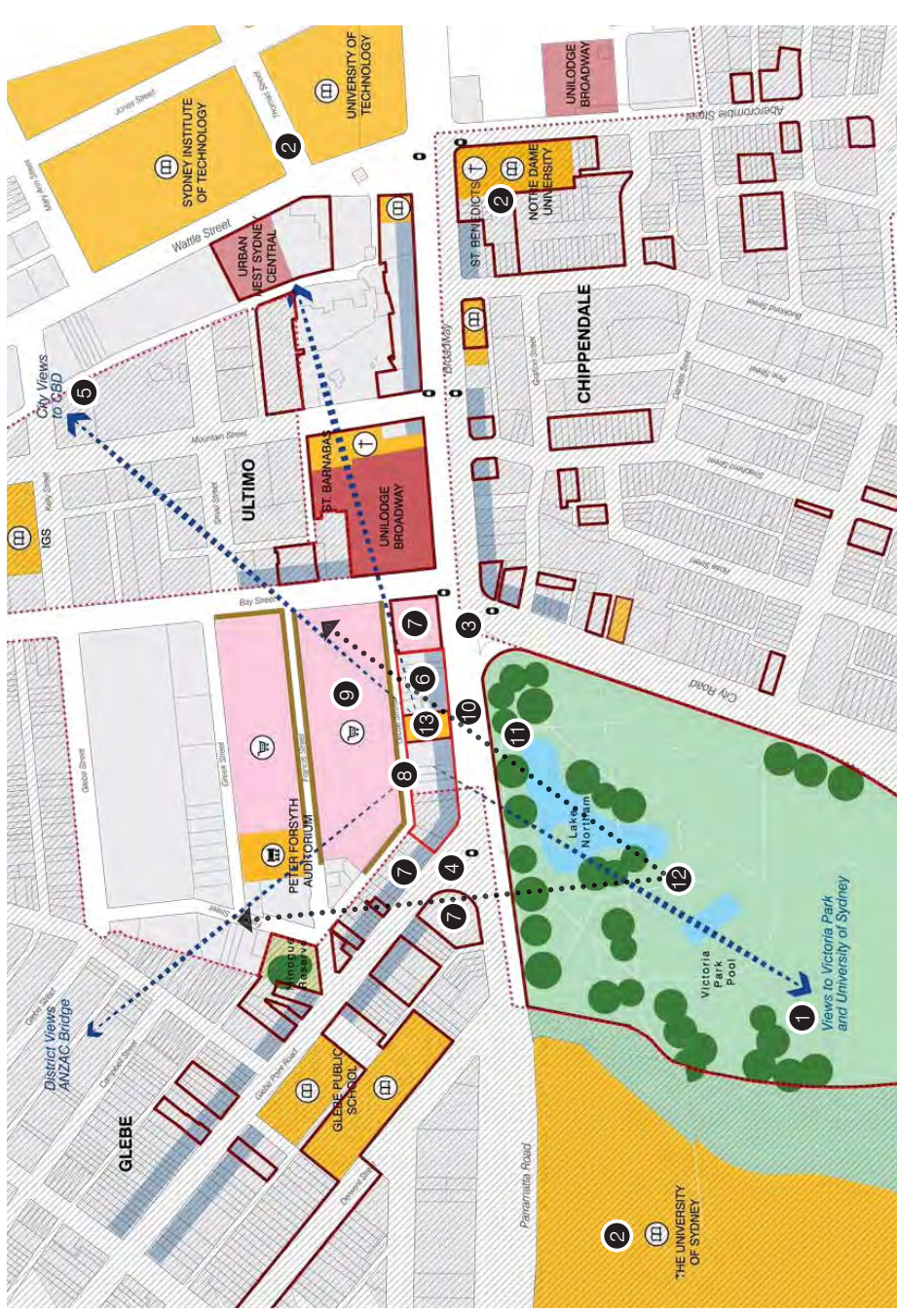

Opportunities and Constraints Plan



b

TOYOTA

Brookway

Brookway

Brookway

Brookway

Brookway

Brookway

Brookway

Brookway

Brookway

Brookway

Brookway

Brookway

Brookway

Brookway

Brookway

Brookway

Brookway

Brookway

Brookway

Brookway

Brookway

Brookway

Brookway

Brookway

Brookway

Brookway

Brookway

Brookway



HealthInt. Beauty & Health

SUBWAY

Crashai

天和美菜

天和風菜

BUSINESS READY

天和美菜

TAXI

天和美菜

天和美菜

天和美菜

天和美菜

天和美菜

天和美菜

BROADWAY CROWN

2 Urban Design Principles

signature **LOCCALS**

WATTLE STREET
Darling Harbour
Anzac Bridge
Harbour Bridge

signature **\$15 COCKTAILS**

Repairs

MONDAY
250g Sirloin
Steak
\$15

WEDNESDAY
Ribs
& Wings
\$20

FRIDAY
Bucket of
Corona
\$25

INFO@STONEDCRO



50

PREPARE TO STOP



2.1 Urban Design Principles

1. Heritage Interfaces

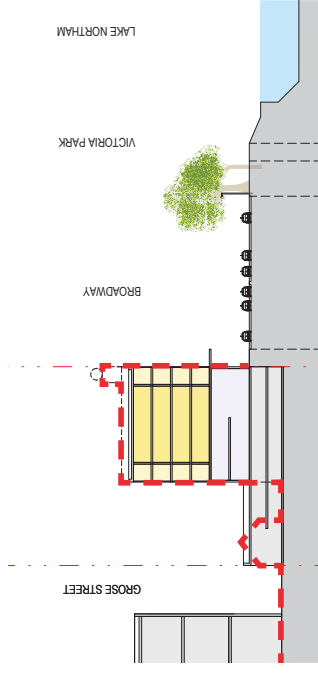

- Develop a sympathetic built form response which respects the existing heritage interfaces around the area of study. These include the Glebe Heritage Conservation area to the north, the Grace Bros. building to the east, and University Hall to the west.

2. Site Connectivity

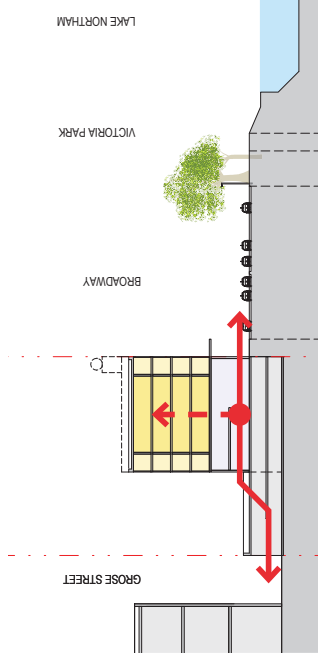

- Seek out opportunities to integrate through site connections between Broadway and Grose Street to increase permeability and encourage movement across the site.

3. Built Form Continuity + Active Frontage

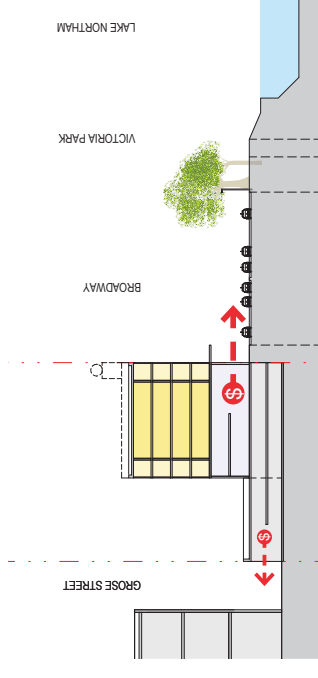

- Develop uses (retail or otherwise) which maintain an edge to Broadway which is vibrant and active.
- Develop a coherent street wall facade to Broadway and Glebe Point Road that provides continuity of built form while responding to local character.
- Encourage uses along Grose Street to develop a level of 'fine grain' development and a new point of activation.

4. Solar Access & Natural Cross Ventilation

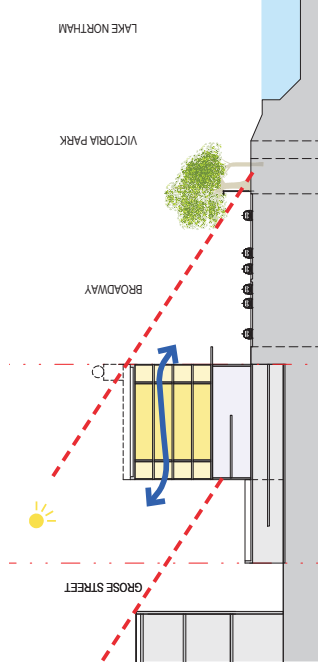

- Develop built form design solutions which maximise solar access to each dwelling while minimising the impact of overshadowing on Victoria Park.
- Develop built form solutions which assist in achieving natural cross ventilation

5. Noise

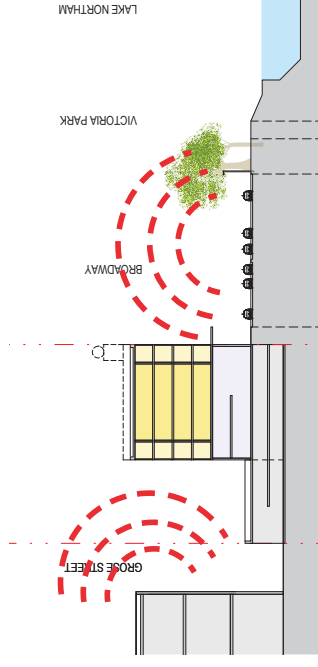

- Explore built form solutions that mitigate the impacts of noise emanating from Broadway and the Broadway Shopping Centre roof plant.
- Determine the feasibility of residential and non-residential uses on this site. A summary of the acoustic report undertaken by Acoustic Logic into the effects of residential development within the study area is located on page 25 of this report.

6. Views

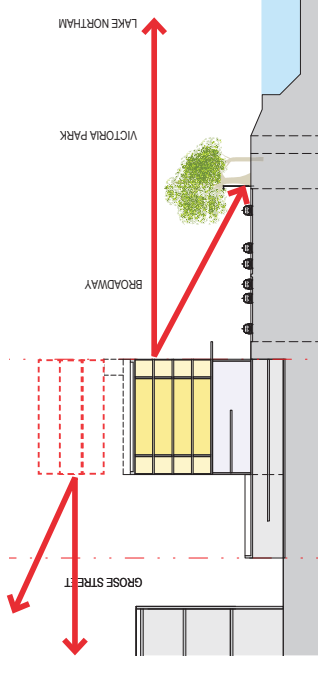

- Maximise where possible views to Victoria Park, Lake Northam and the University of Sydney to the south and the city centre to the north and east.



COLLINS

245
BROADWAY

HOTELS

MOTUSA



LANE
FOR
LEFT TURN

UNIVERSITY COLLEGE OF HUMANITIES AND SPECIAL OFFICES

W114 ROAD

3 Built Form Options



3.1 Options Tested

Option 1 – Heritage Integration

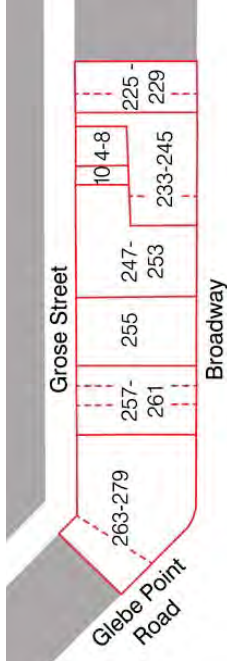

Option 1 – Amalgamation Plan



Assumptions:

- Zero setbacks to all boundaries create street walls along Broadway, Glebe Point Road, and Grose Street.
- Existing buildings at 225 Broadway and 4-8 Grose Street have heritage value.
- The façades of 225-227, 247-253, 261, 263, and 279 Broadway have heritage value.
- Step-down in street wall height from Broadway to Glebe Point Road.
- Maximum height of development limited to RL 37.98 to match the heritage building at 255 Broadway.
- Amalgamation into a total of 7 development lots as shown in the plan above.

Yield Summary:

Site Area	4,650
GFA Achieved	12,138
Aggregate FSR Achieved	2.61

Option 2 – Amalgamation

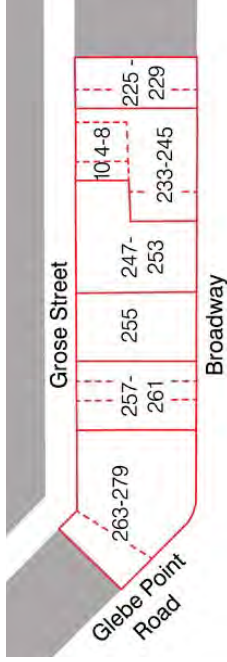

Option 2 – Amalgamation Plan

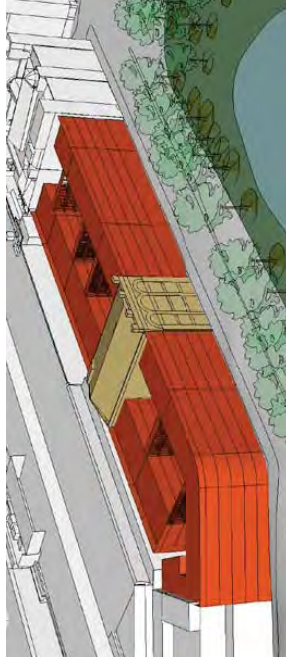

Assumptions:

- Zero setbacks to all boundaries create street walls along Broadway, Glebe Point Road, and Grose Street.
- Existing building at 225 Broadway has heritage value.
- Continuous street wall height from Broadway to Glebe Point Road.
- Maximum height of development limited to RL 37.98 to match the heritage building at 255 Broadway.
- Amalgamation into a total of 6 development lots as shown in the plan above.

Yield Summary:

Site Area	4,650
GFA Achieved	13,765
Aggregate FSR Achieved	2.96

Option 3 – Amalgamation (With Additional Height)

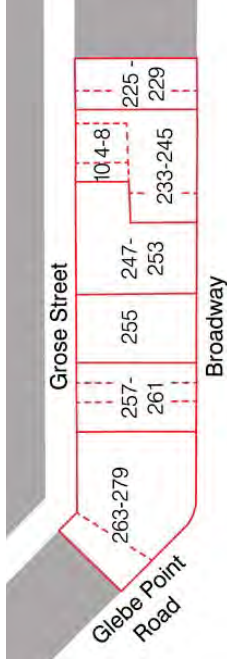

Option 3 – Amalgamation Plan



Assumptions:

- Zero setbacks to all boundaries create street walls along Broadway, Glebe Point Road, and Grose Street.
- Existing building at 225 Broadway has heritage value.
- Continuous street wall height from Broadway to Glebe Point Road.
- Maximum height of development limited by avoiding excessive overshadowing impacts on Victoria Park.
- Amalgamation into a total of 6 development lots as shown in the plan above.

Yield Summary:

Site Area	4,650
GFA Achieved	15,211
Aggregate FSR Achieved	3.27

Option 4a - 4c – Non-Residential Uses

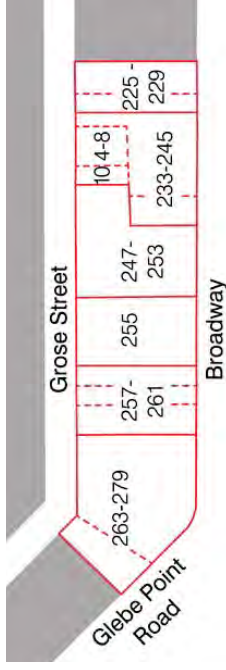

Option 4a - 4c – Amalgamation Plan

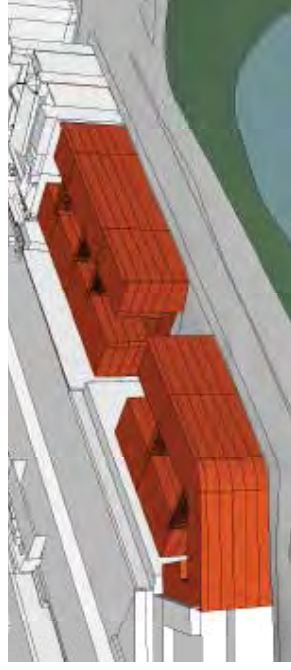

Assumptions:

- Zero setbacks to all boundaries create street walls along Broadway, Glebe Point Road, and Grose Street.
- Existing building at 225 Broadway has heritage value.
- Continuous street wall height from Broadway to Glebe Point Road.
- Maximum height of development limited by avoiding excessive overshadowing impacts on Victoria Park.
- Amalgamation into a total of 6 development lots as shown in the plan above.
- The narrow courtyard building type is based on a commercial/education building - The L5 Building at the University of New South Wales which is located in a similar urban context fronting Anzac Parade, a busy main road with similar acoustic issues.

Option 4a - Student Housing		Option 4b - Commercial / retail	
Site Area	4,650	GFA - Commercial/retail (4b)	16,882
GFA - Student Housing	14,449	Aggregate FSR Achieved (4b)	3.63
Aggregate FSR Achieved	3.11	Option 4c - Hotel	
		GFA - Hotel (4c)	15,263
		Aggregate FSR Achieved (4c)	3.26

Efficiency of Built Form Envelopes

The building envelopes proposed has the potential for a variety of uses. In order to arrive at a plausible Gross Floor Area (GFA) for each use, a efficiency factor has been assigned. This factor is expressed as a percentage and can be applied to the Building Envelope Area (BEA) to obtain an approximate GFA. The nominated building use, efficiency factor specific precedent on which the factor is based is outlined below.

Building Use	Reference	Indicative Efficiency
Residential - Single aspect multi-level apartment building with gallery access and ground floor entry. (Galleries in reference assumed to be enclosed for purposes of comparison and counted as Gross Floor Area)	City-West Housing Apartments, North Everleigh(Architectus) Typical floor plate measurements: BEA - 1510m ² GFA - 1150m ²	75%
Commercial/retail - Small / narrow floor plate commercial buildings suitable for strata office or education/seminar uses with lift and stair access.	Planning Proposal for 263-279 Broadway (SUB Architects) Typical floor plate measurements: BEA - 990m ² GFA - 900m ²	90%
Hotel - Multi-storey hotel/short stay accommodation with single aspect rooms and enclosed gallery access.	Parkroyal Parramatta (Architectus) Typical floor plate measurements: BEA - 720m ² GFA - 615m ²	85%
Student Housing - Multi-floor student housing type comprising four to six bedroom configurations with communal kitchen and recreational facilities on each floor.	University of Newcastle Student Housing (Architectus) Typical floor plate measurements: BEA - 830m ² GFA - 580m ²	70%

These efficiency percentages may be used as rules of thumb to determine the yield of development options based on use. They are derived from evidence based research which has analysed similar building typologies and uses. It is to be used as an approximation tool and is non-binding. Each subject site to more detailed design and investigation of sites.

3.2 Option 1 – Heritage Integration

Option 1 – Built Form Model



Option 1 – Typical Section

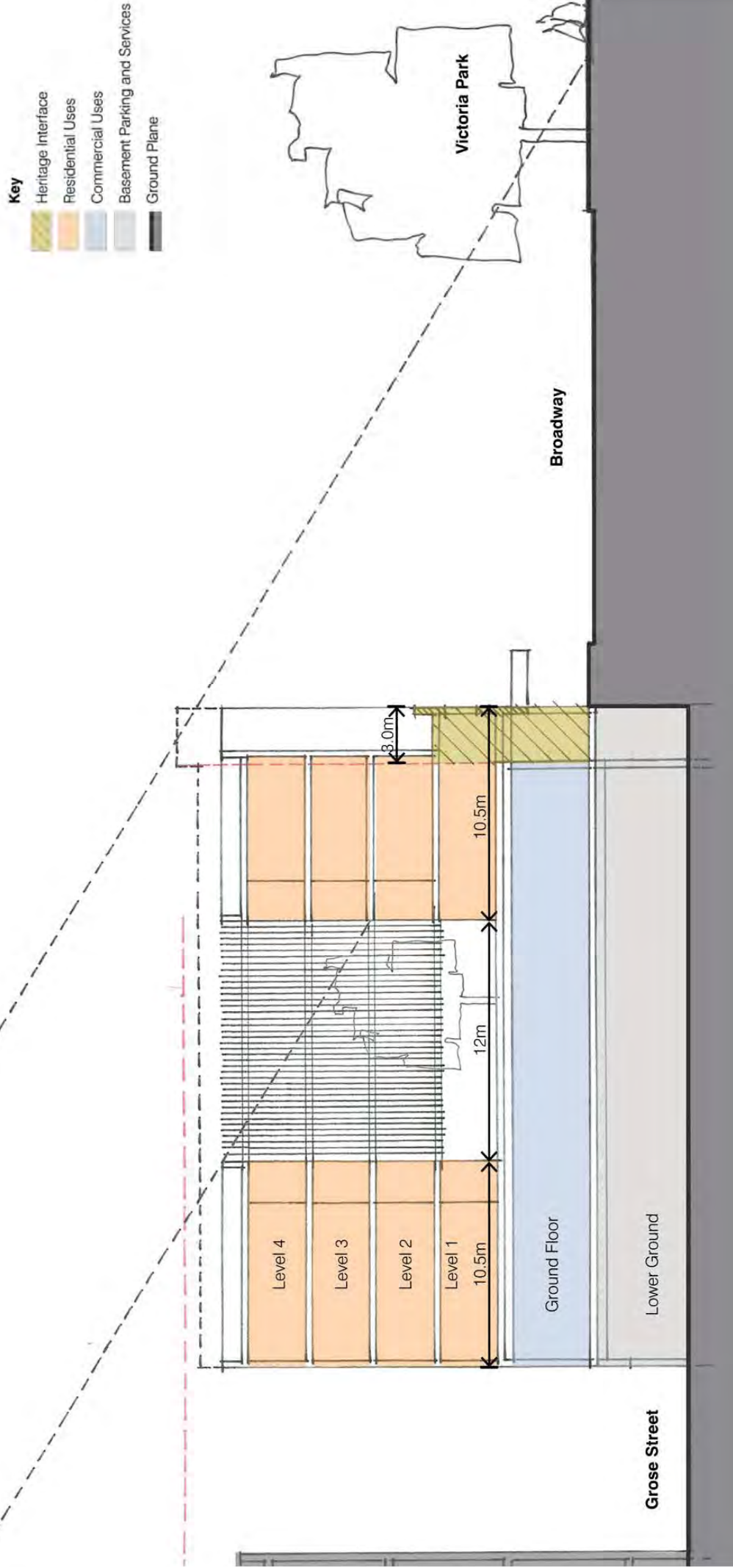

Scale 1:200 @ A3



Option 1 – Commercial Ground Floor Plan (West)

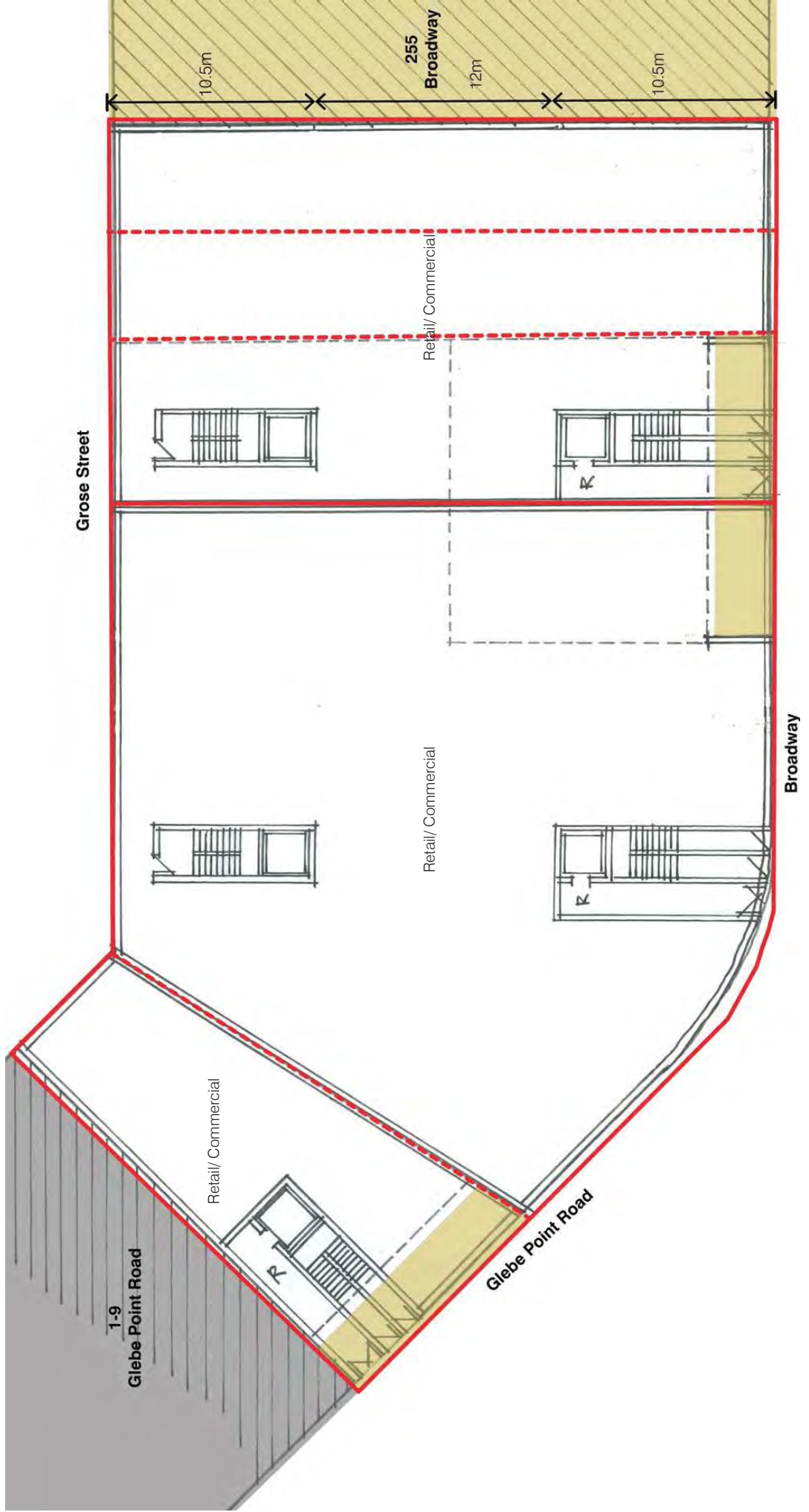

Option 1 – Commercial Ground Floor Plan (East)

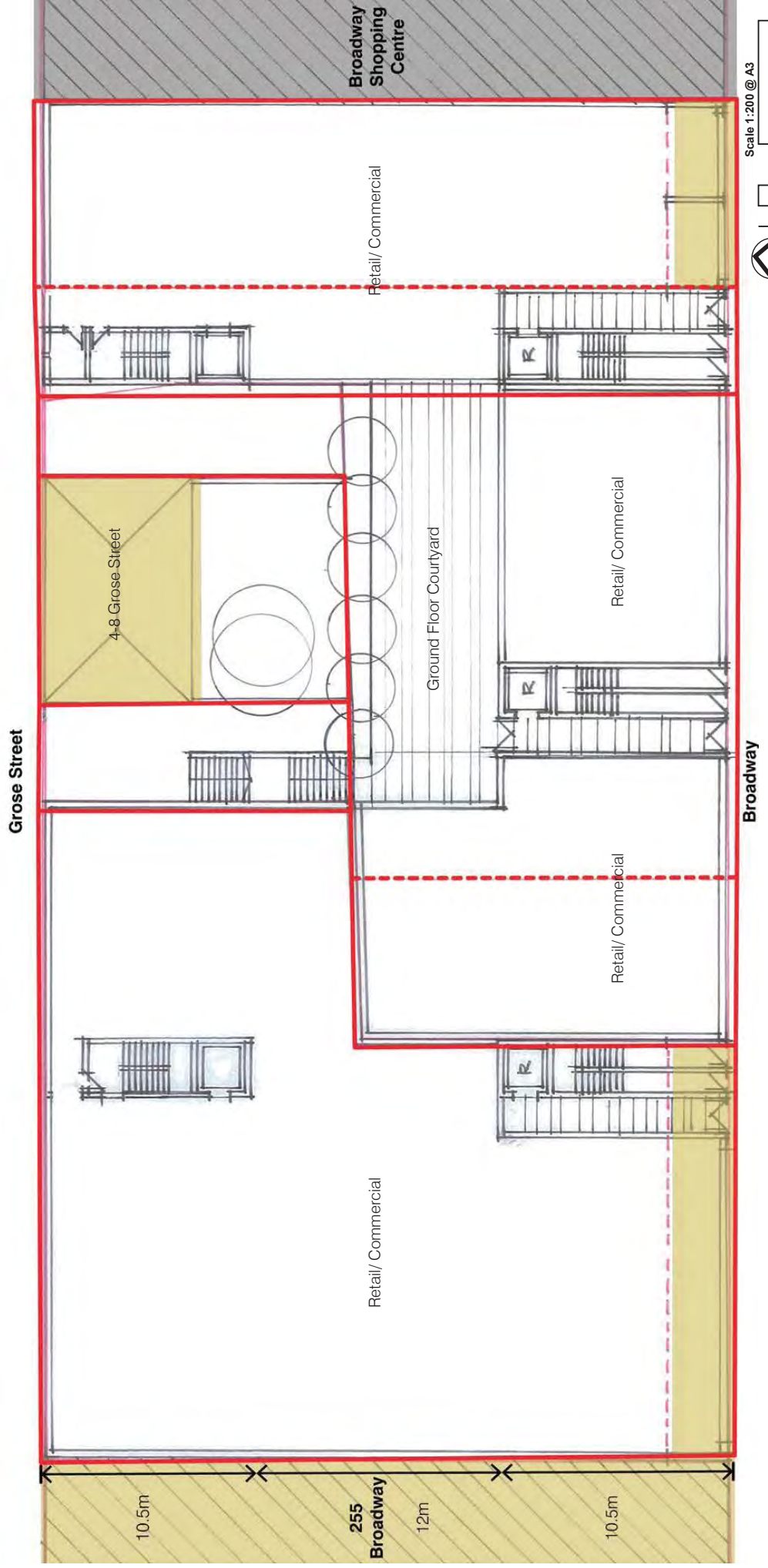

Option 1 – Typical Residential Floor Plan (West)

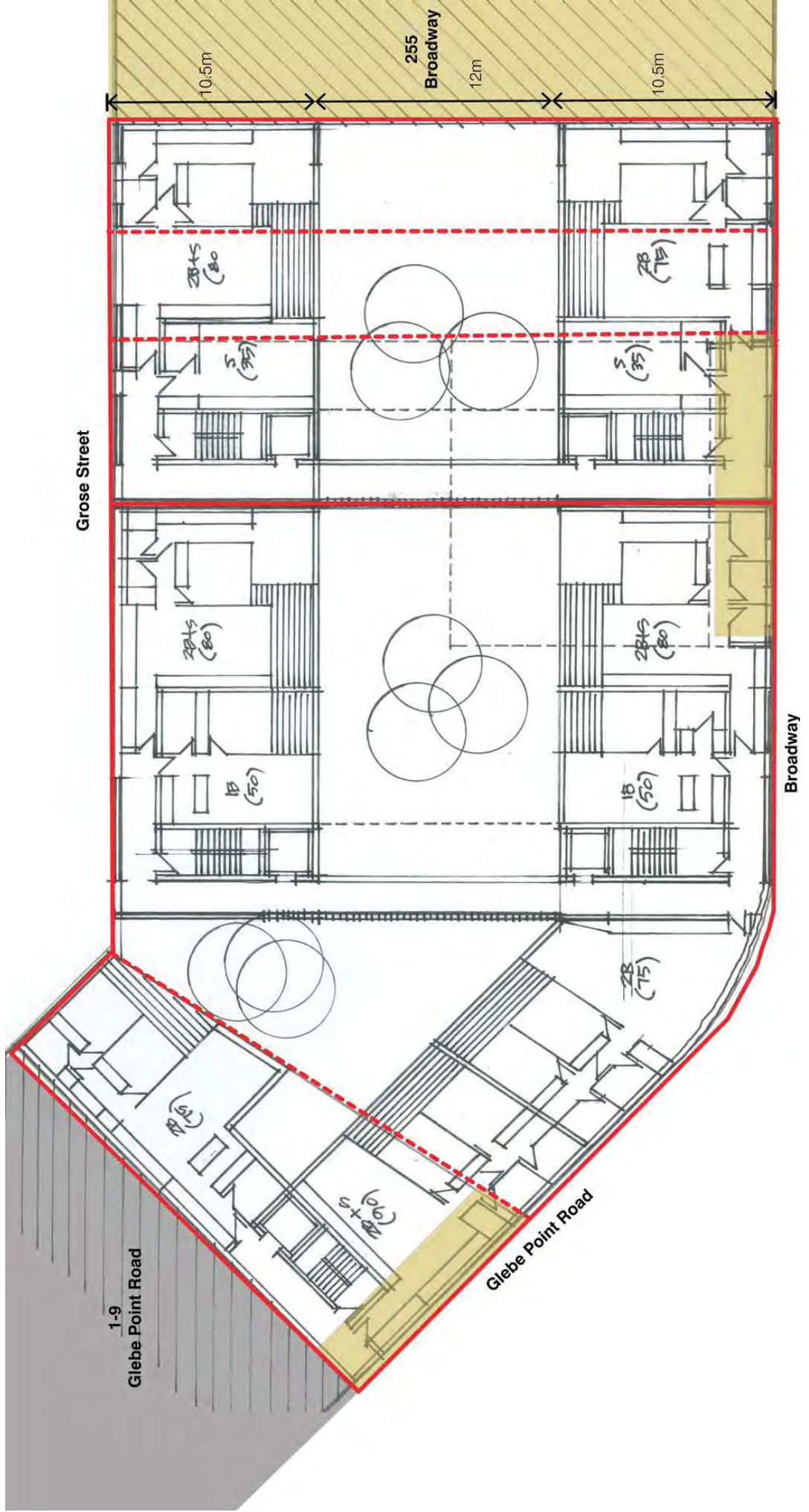

Option 1 – Typical Residential Floor Plan (East)

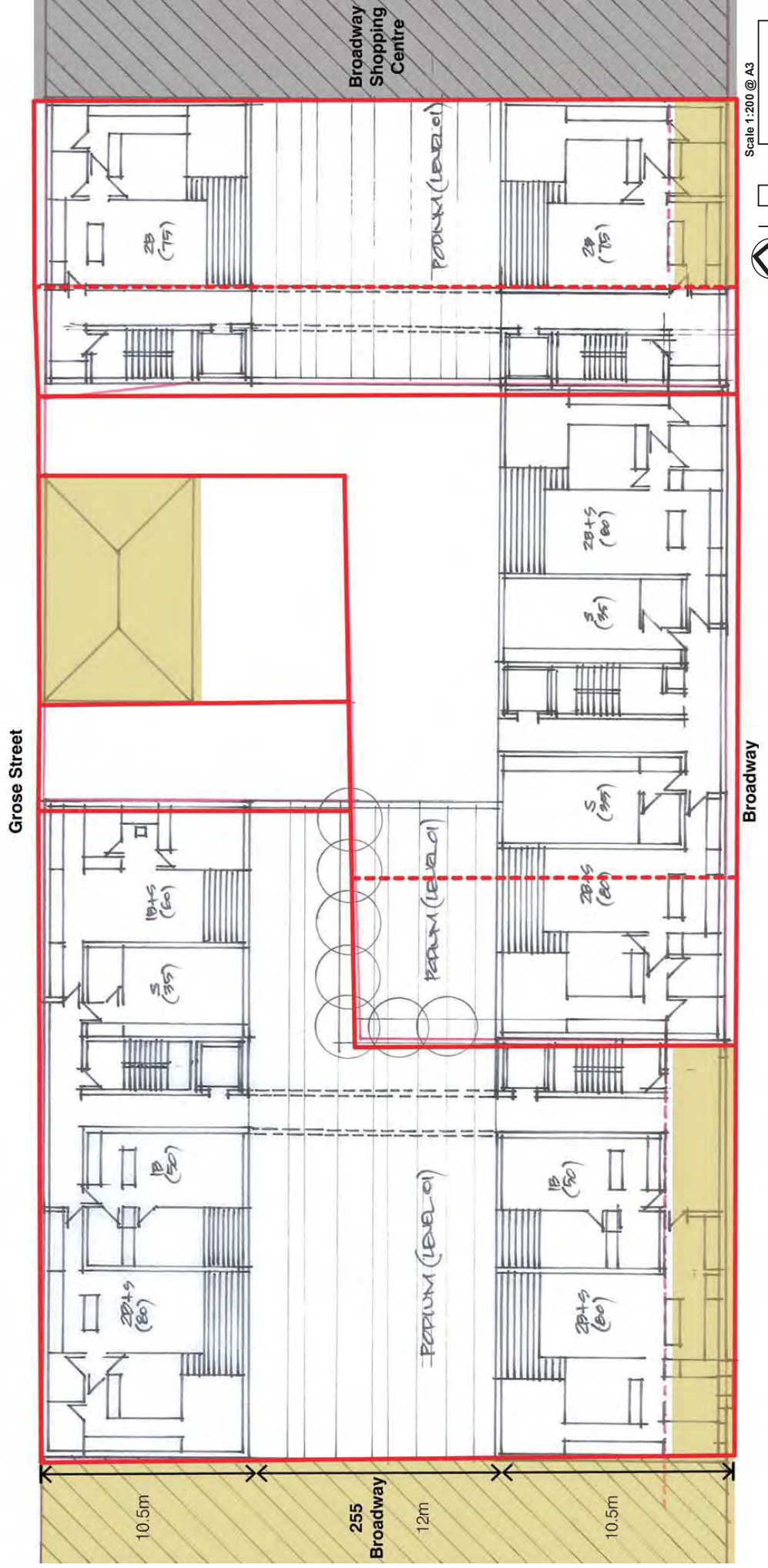

Option 1 – Upper Residential Floor Plan (West)

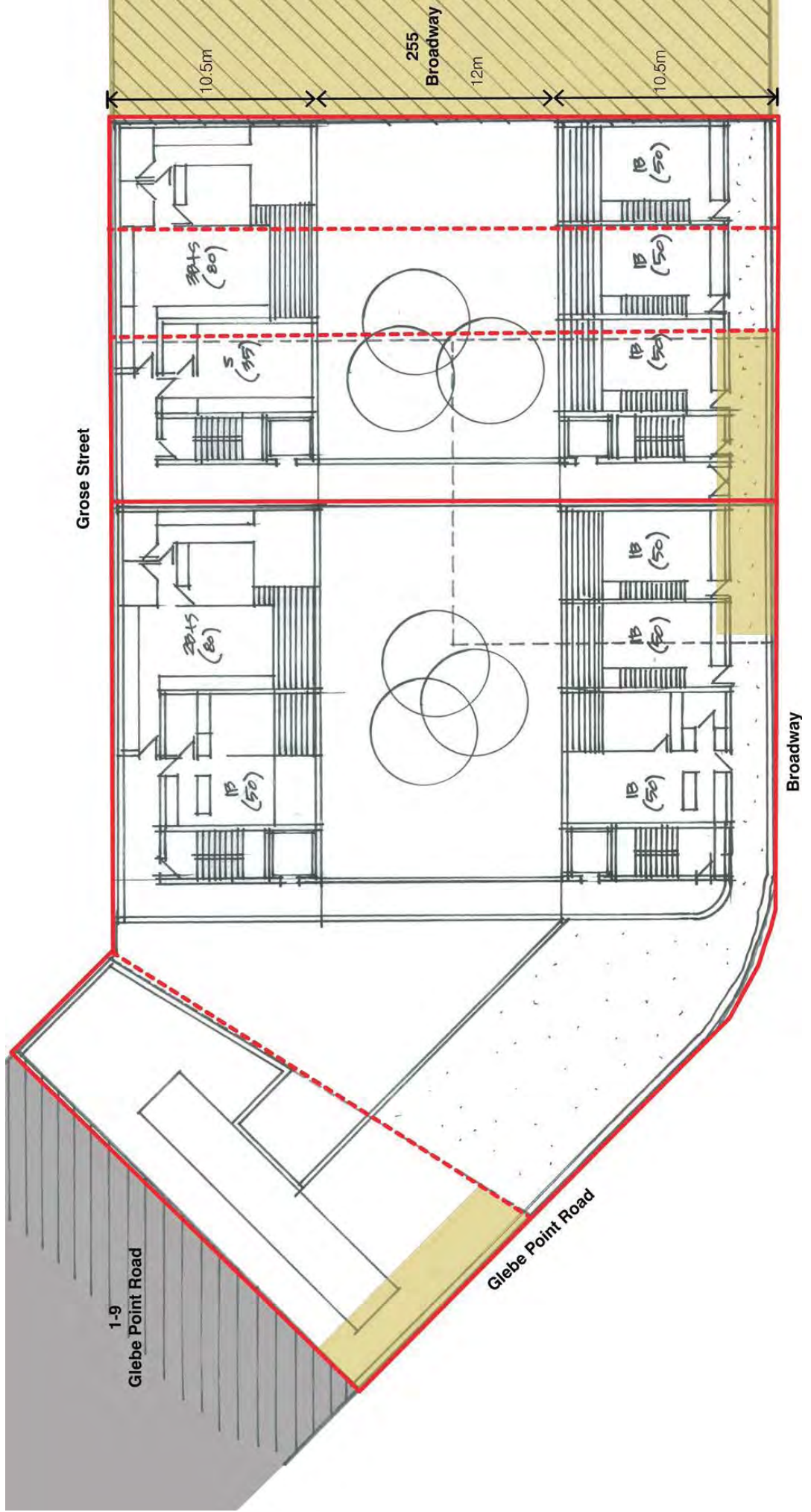

Option 1 – Upper Residential Floor Plan (East)

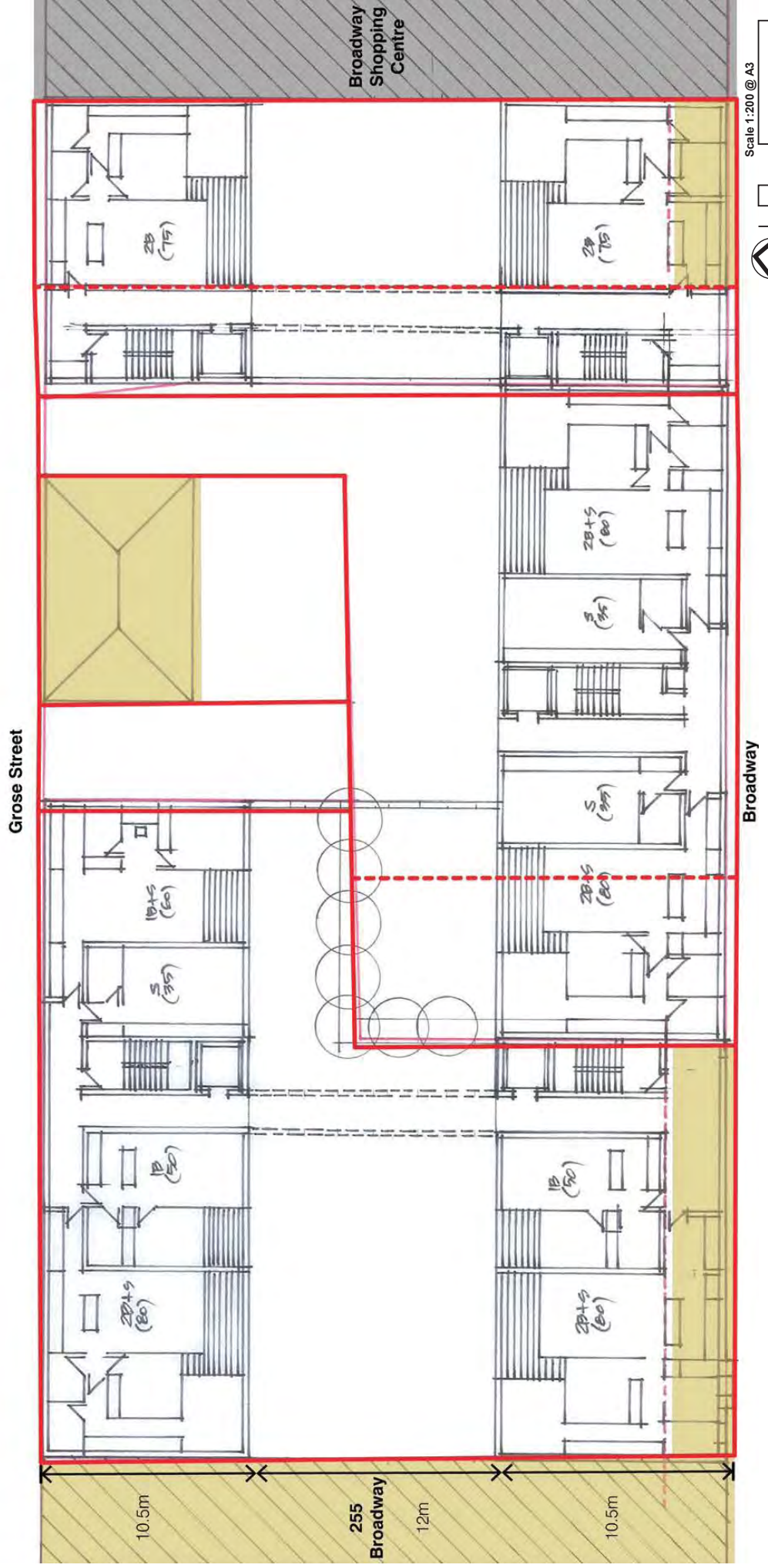

Option 1 – View Analysis



View east along Broadway from Sydney University

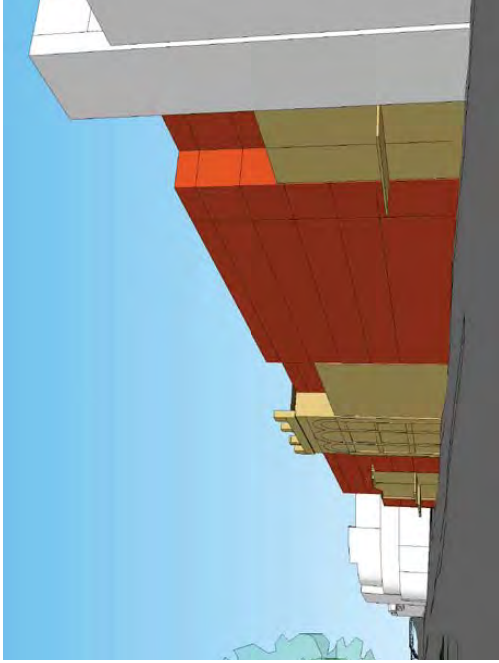

View north-west across Broadway from City Road

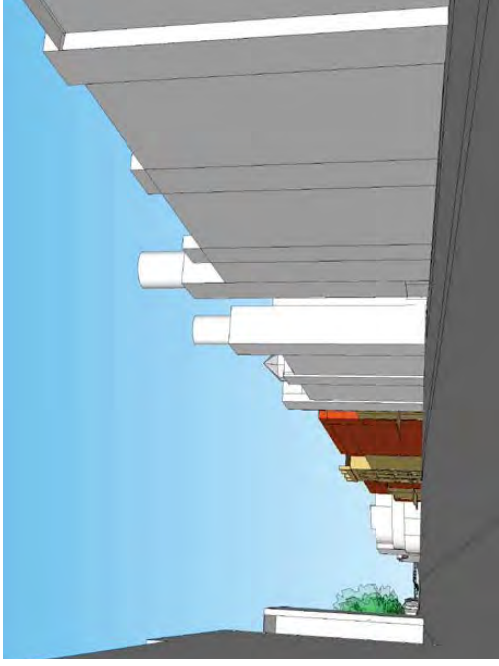

View west along Broadway from Buckland Street



View south-east along Glebe Point Road towards Victoria Park



View of Broadway from Lake Northam, Victoria Park



View of Broadway from the south side of Victoria Park Pool

Summary

Public Private

Advantages

- All street frontages incorporate heritage and potential heritage buildings or facade elements.
- The street wall transitions in scale, stepping from the five storey Broadway frontage down to the three storey Glebe Point Road frontage in recognition of the local character and scale of each place.
- Overshadowing of Victoria Park is minimised.

Advantages

- A high degree of residential amenity is provided for the majority of apartments through a protected internal series of courtyards, some of which feature openings to the north, allowing increased solar access and natural ventilation.

Disadvantages

- Integrating new built forms and facade elements adds complexity to design and construction.
- The fourth and fifth storey step back from Glebe Point Road detracts from this street wall frontage by limiting built form continuity northwards from the Broadway intersection and presenting a weak corner across from University Hall.

Disadvantages

- Depending on development order, some apartments are not shielded by road noise (due to dog leg lot configuration).

Conclusion

- The retention of existing heritage and contributing buildings and facade elements can facilitate the continuation of this area's local character.
- The visual prominence of the important Broadway and Glebe Point Road corner is reduced by the stepping back of the fourth and fifth floors away from Glebe Point Road.
- The universal limit to building height facilitates a high degree of residential amenity to apartments throughout the study area by sharing solar access and limiting noise ingress.

Indicative Yield Schedule

Level	225-229 Broadway			4-8 Grose			10 Grose			283-245 Broadway			247-263 Broadway			265 Broadway			267-261 Broadway			263-279 Broadway			Res GFA (m ²)
	BEA (m ²)	Com/Ret GFA (m ²)	Res GFA (m ²)	BEA (m ²)	Com/Ret GFA (m ²)	Res GFA (m ²)	BEA (m ²)	Com/Ret GFA (m ²)	Res GFA (m ²)	BEA (m ²)	Com/Ret GFA (m ²)	Res GFA (m ²)	BEA (m ²)	Com/Ret GFA (m ²)	Res GFA (m ²)	BEA (m ²)	Com/Ret GFA (m ²)	Res GFA (m ²)	BEA (m ²)	Com/Ret GFA (m ²)	Res GFA (m ²)				
Ground - Broadway	465	446	0	95	86	0	530	531	0	837	753	0	641	577	0	643	643	0	1148	1148	0	1033	0		
L01	248	0	204	-	-	-	0	251	251	541	406	406	641	641	641	402	402	0	302	302	0	753	504		
L02	236	0	204	-	-	-	0	251	251	541	406	406	641	641	641	402	402	0	302	302	0	753	504		
L03	272	0	204	-	-	-	0	251	251	541	406	406	641	641	641	402	402	0	302	302	0	753	504		
L04	272	0	204	-	-	-	0	251	251	541	406	406	641	641	641	402	402	0	302	302	0	753	504		
L05	272	0	204	-	-	-	0	251	251	541	406	406	641	641	641	402	402	0	302	302	0	753	504		
Subtotal	446	446	857	-	-	-	86	86	1002	753	1623	1623	2308	2308	1148	1148	1148	1148	579	579	1148	1033	1775		
Total GFA	1302	1302	857	-	-	-	86	86	1553	2376	4699	4699	2308	2308	1148	1148	1148	1148	1726	1726	2808	4650	4650		
Site Area	476	2.7 :1	857	0.5 :1	86	0.5 :1	80	80	641	2.4 :1	641	2.4 :1	641	641	3.6 :1	643	643	643	643	643	2.7 :1	1148	2.4 :1		
FSR	2.7 :1	2.7 :1	2.4 :1	0.5 :1	0.5 :1	0.5 :1	0.5 :1	0.5 :1	2.4 :1	2.4 :1	2.8 :1	2.8 :1	3.6 :1	3.6 :1	3.6 :1	2.7 :1	2.7 :1	2.7 :1	2.7 :1	2.7 :1	2.4 :1	2.4 :1	2.6T		

Site Area	4,650
GFA Achieved	12,138
Aggregate FSR Achieved	2.6T

Conversions from Built Envelope Area (BEA) to Gross Floor Area (GFA) vary depending upon proposed building use. Efficiency factors used are located on page 39 for reference.

3.3 Option 2 – Lot Amalgamation

Option 2 – Built Form Model

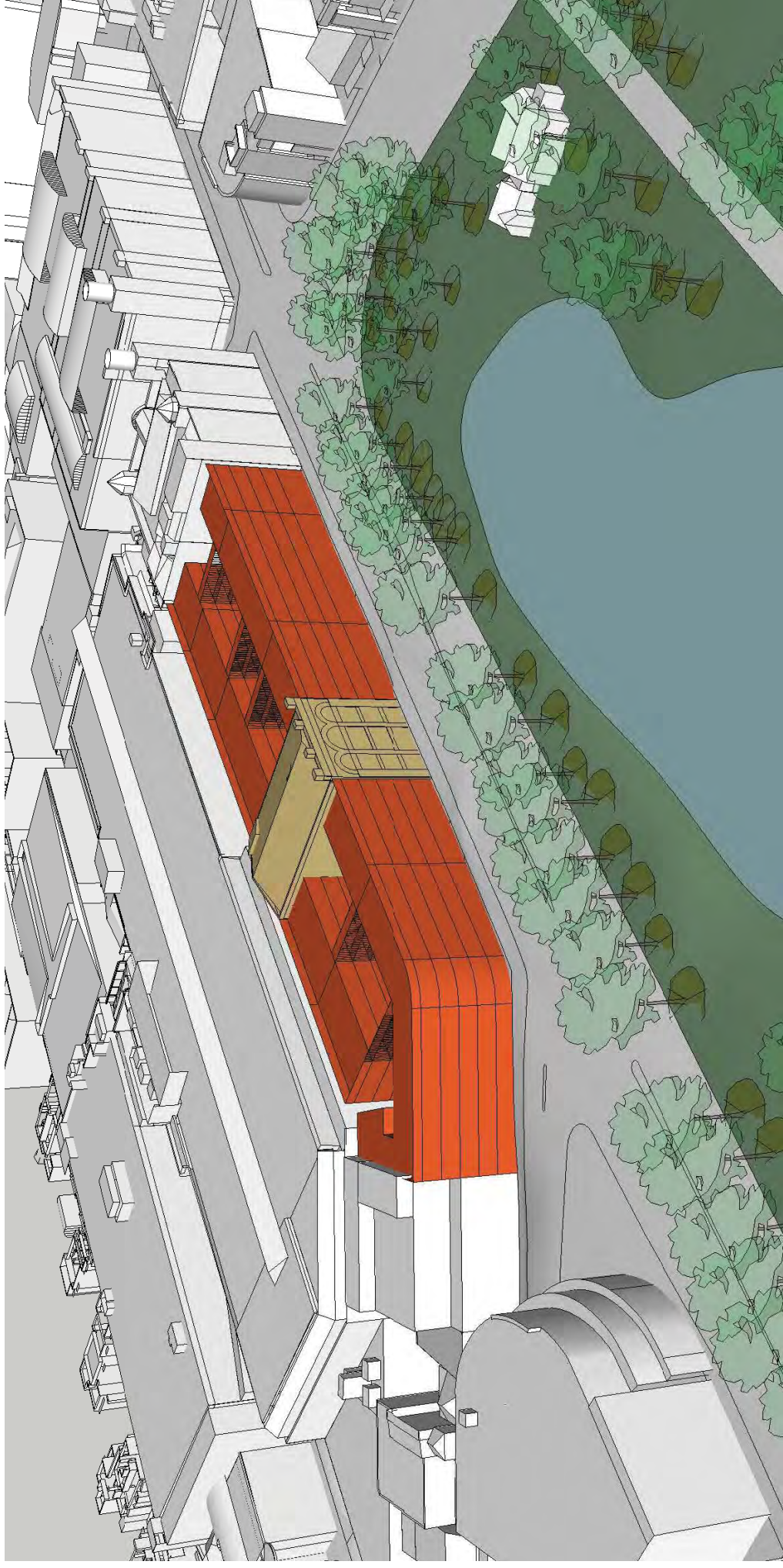

Option 2 – Typical Section

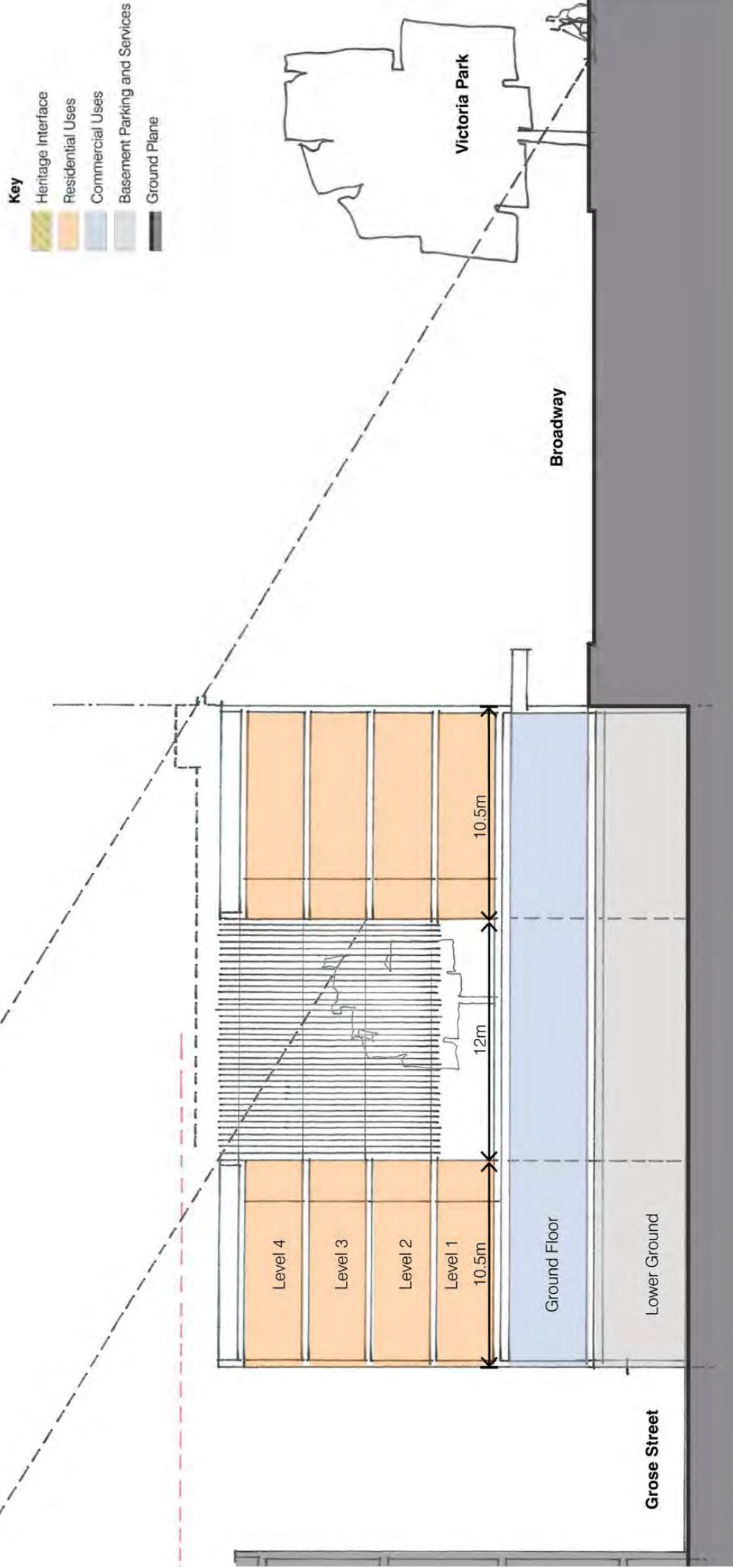

Option 2 – Commercial Ground Floor Plan (West)

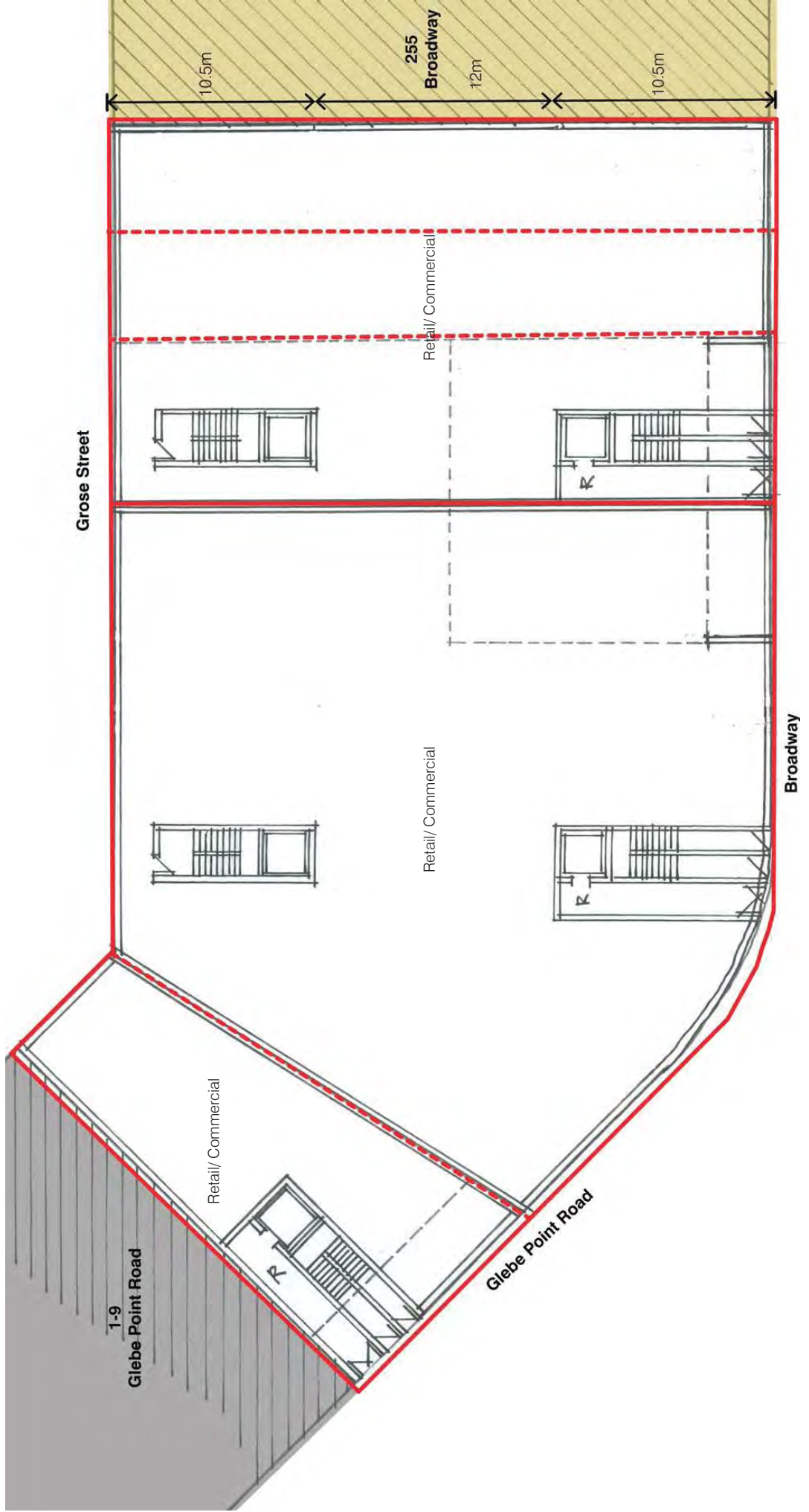

Option 2 – Commercial Ground Floor Plan (East)

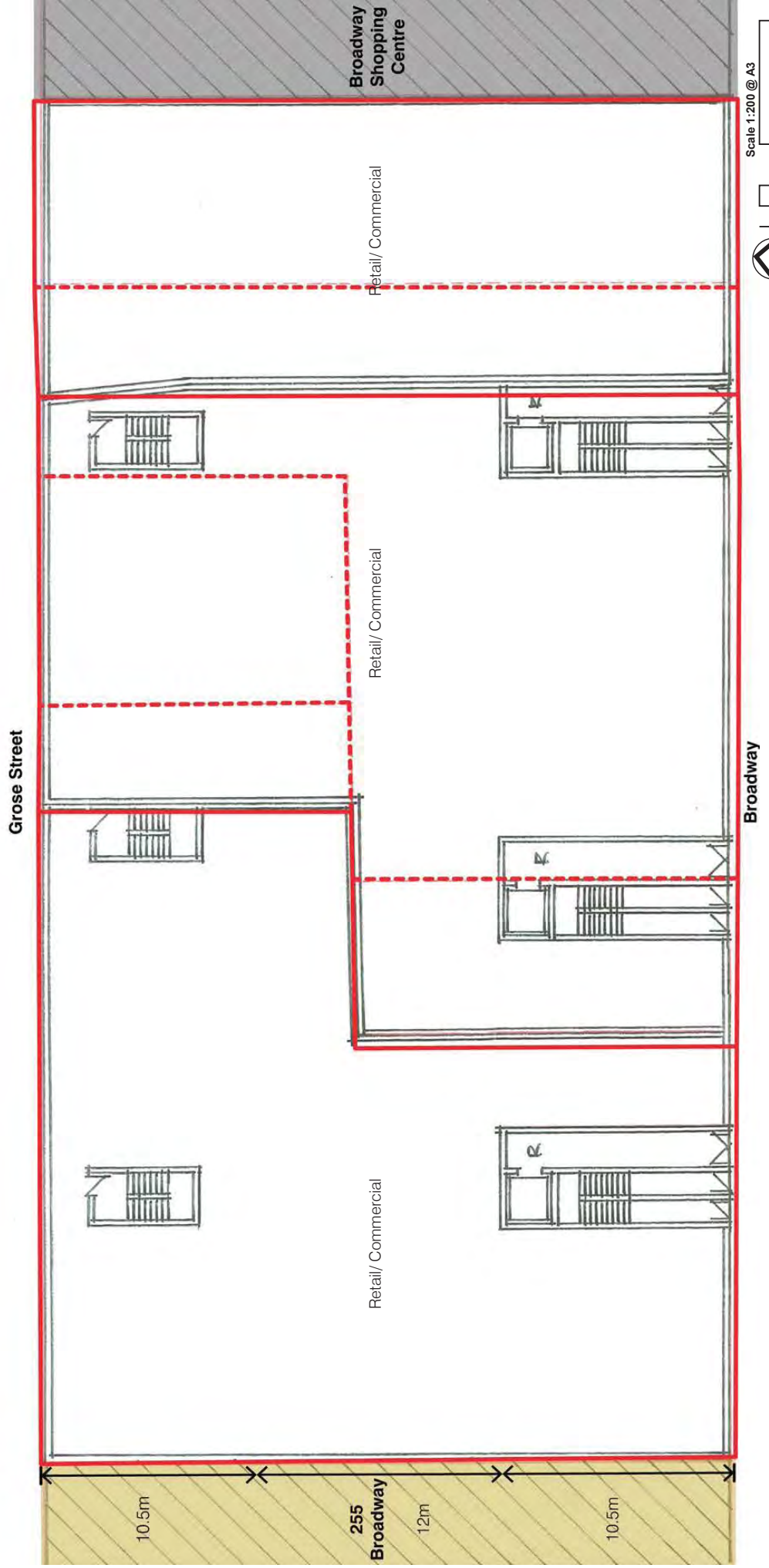

Option 2 – Typical and Upper Residential Floor Plan (West)

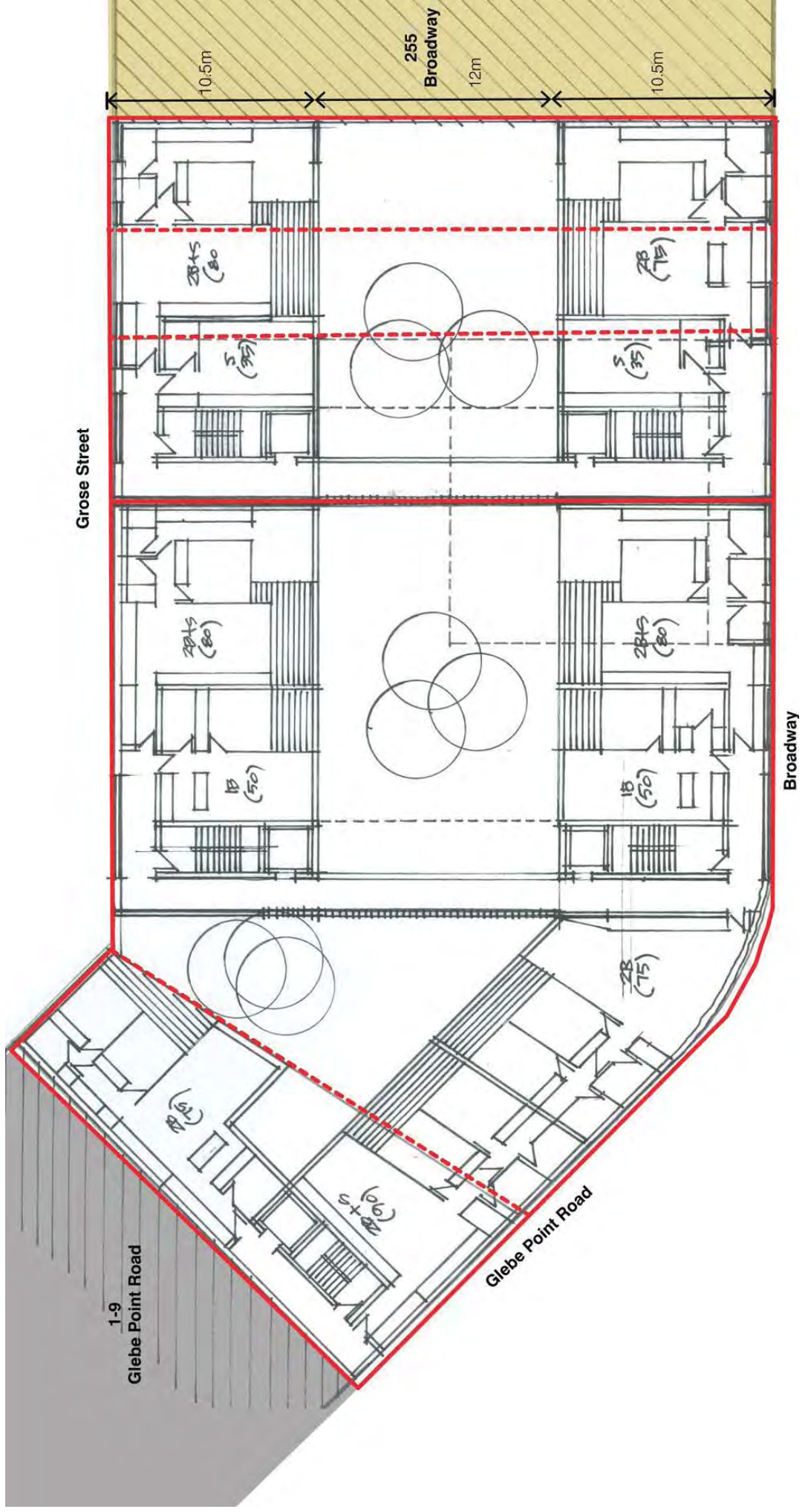

Option 2 – Typical and Upper Residential Floor Plan (East)

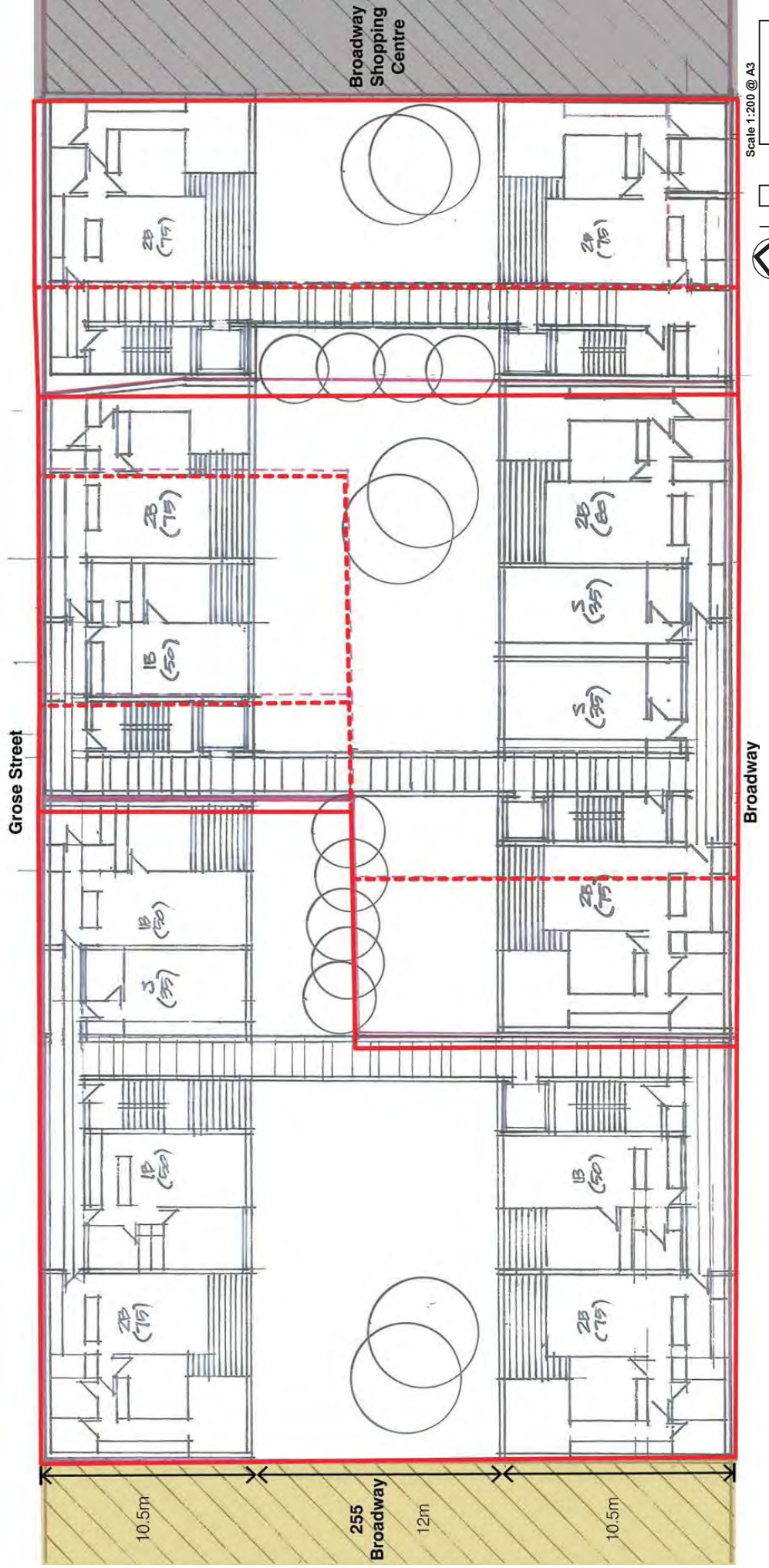

Option 2 – View Analysis



Option 2 – View east along Broadway from Sydney University

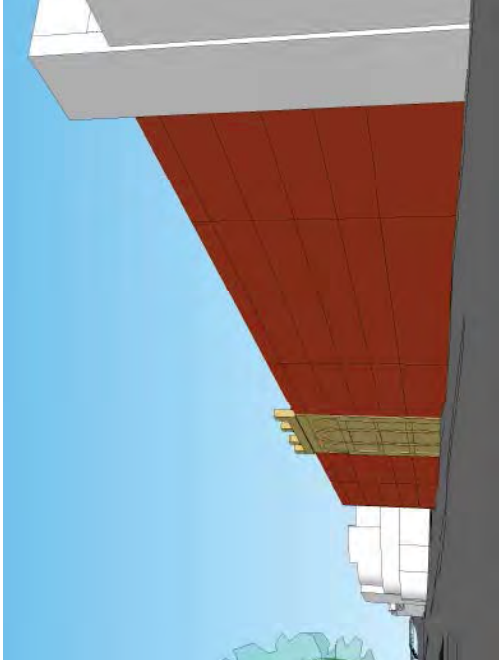

Option 2 – View north across Broadway from City Road

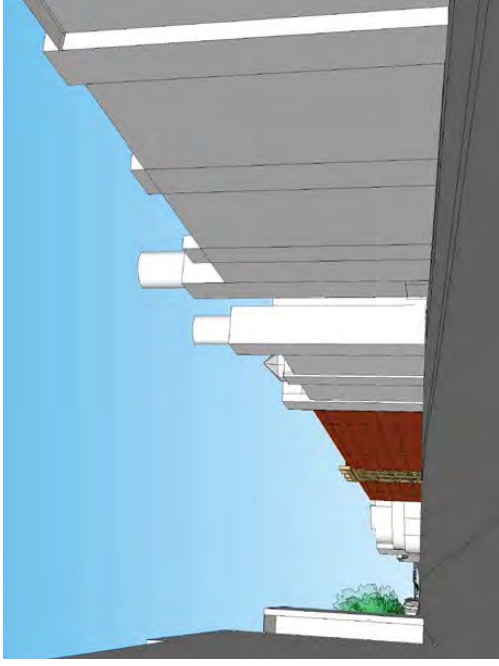

Option 2 – View west along Broadway from Buckland Street



Option 2 – View south along Glebe Point Road



Option 2 – View of Broadway from the south side of Lake Northam, Victoria Park



Option 2 – View of Broadway from the south side of Victoria Park Pool

Option 2 – Summary

Public		Private
Advantages		
<ul style="list-style-type: none"> – The coherent five storey street wall to Broadway creates visual continuity between the Broadway Shopping Centre, 255 Broadway, and University Hall. – The five storey street wall curves around the corner to Glebe Point Road, creating a positive relationship with the University Hall building opposite, and a distinct 'threshold' entry space into Glebe. – Overshadowing of Victoria Park is minimised. 		

Disadvantages		
<ul style="list-style-type: none"> – Only 255 Broadway is retained as a heritage building – the other potential heritage elements are lost. – The fourth and fifth storey step back from Glebe Point Road detracts from this street wall frontage by limiting built form continuity northwards from the Broadway intersection. – Continuing the five storey street wall through to the end of the study area necessitates that another property (ideally 1-9 Glebe Point Road) provides a height transition from Broadway to Glebe Point Road. 		

Conclusion

- The existing heritage building at 255 Broadway may be retained as a distinct and high quality component of the Broadway street frontage character.
- The visual prominence of the important Broadway and Glebe Point Road corner is increased by the continuous five storey street wall curving around the corner.
- The universal limit to building height facilitates a high degree of residential amenity to apartments throughout the study area by sharing solar access and limiting noise ingress.

Indicative Yield Schedule

Level	225-228 Broadway			232-245 Broadway			247-253 Broadway			255 Broadway			257-261 Broadway			263-273 Broadway			
	BEA (m ²)	Comp/Ret GFA (m ²)	Res GFA (m ²)	BEA (m ²)	Comp/Ret GFA (m ²)	Res GFA (m ²)	BEA (m ²)	Comp/Ret GFA (m ²)	Res GFA (m ²)	BEA (m ²)	Comp/Ret GFA (m ²)	Res GFA (m ²)	BEA (m ²)	Comp/Ret GFA (m ²)	Res GFA (m ²)	BEA (m ²)	Comp/Ret GFA (m ²)	Res GFA (m ²)	
Ground - Broadway	0	446	0	0	641	0	766	0	641	0	642	0	378	0	1148	0	1033	0	
L01	293	293	0	224	544	0	540	540	577	0	406	0	400	0	300	0	300	0	620
L02	293	293	0	224	544	0	540	540	577	0	406	0	400	0	300	0	300	0	620
L03	293	293	0	224	544	0	540	540	577	0	406	0	400	0	300	0	300	0	620
L04	293	293	0	224	544	0	540	540	577	0	406	0	400	0	300	0	300	0	620
L05	293	293	0	224	544	0	540	540	577	0	406	0	400	0	300	0	300	0	620
Subtotal																			
Total GFA		1343			1623		766	1623	2308		2308		578	1200		1033		2481	
Site Area		476			641		851	641	641		643		643	1148		3514		1148	
FSR		2.8 :1			2.5 :1		2.8 :1	2.8 :1	3.6 :1		2.8 :1		2.8 :1	3.1 :1		3.1 :1		3.1 :1	

Option 2 - Site Wide Key Summary	
Site Area	4,850
GFA Achieved	13,765
Aggregate FSR Achieved	2.96

Conversions from Built Envelope Area (BEA) to Gross Floor Area (GFA) vary depending upon proposed building use. Efficiency factors used are located on page 39 for reference.

3.4 Option 3 – Additional Height

Option 3 – Built Form Model

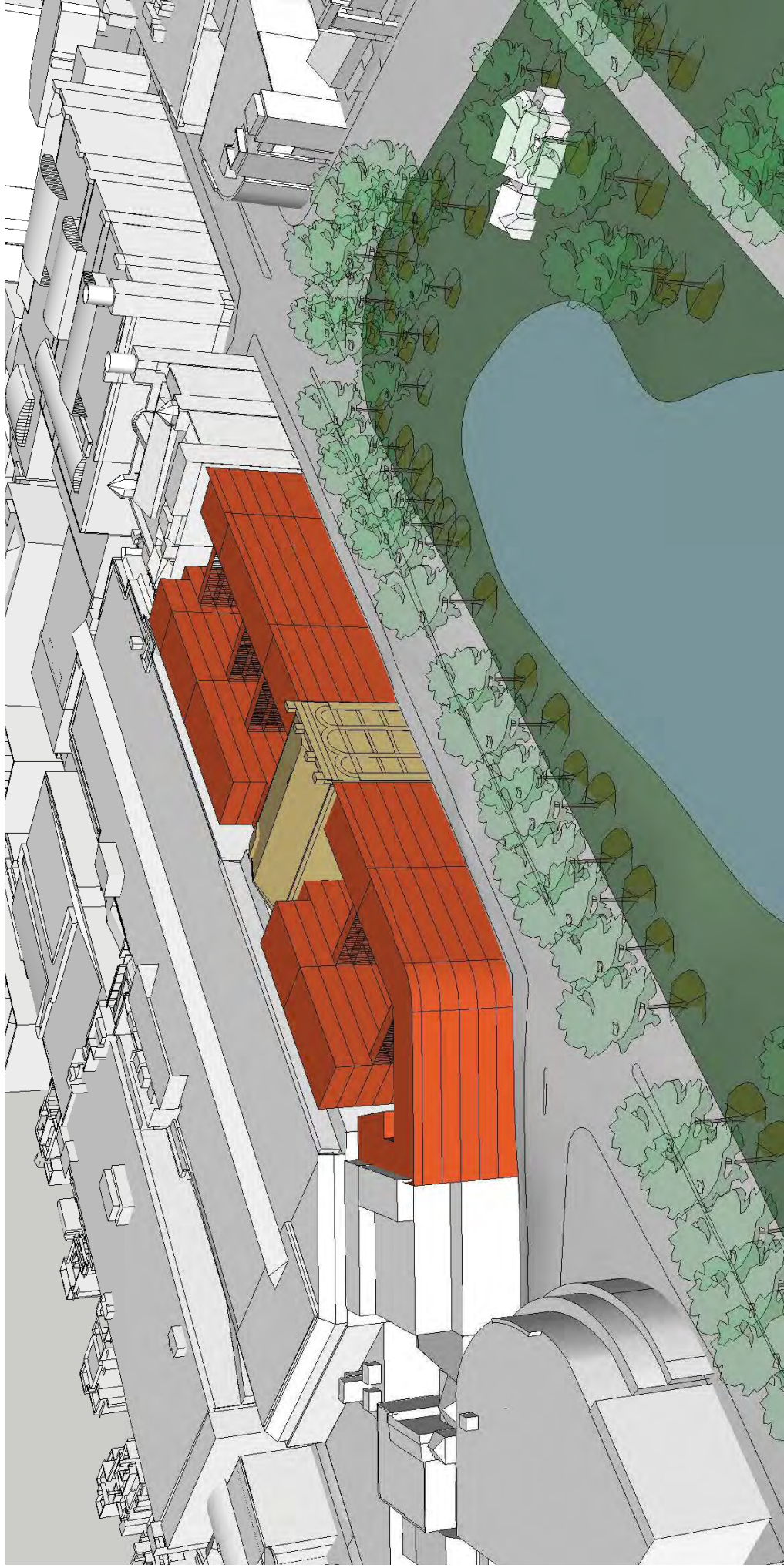

Option 3 – Typical Section

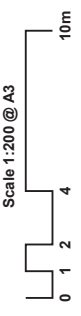
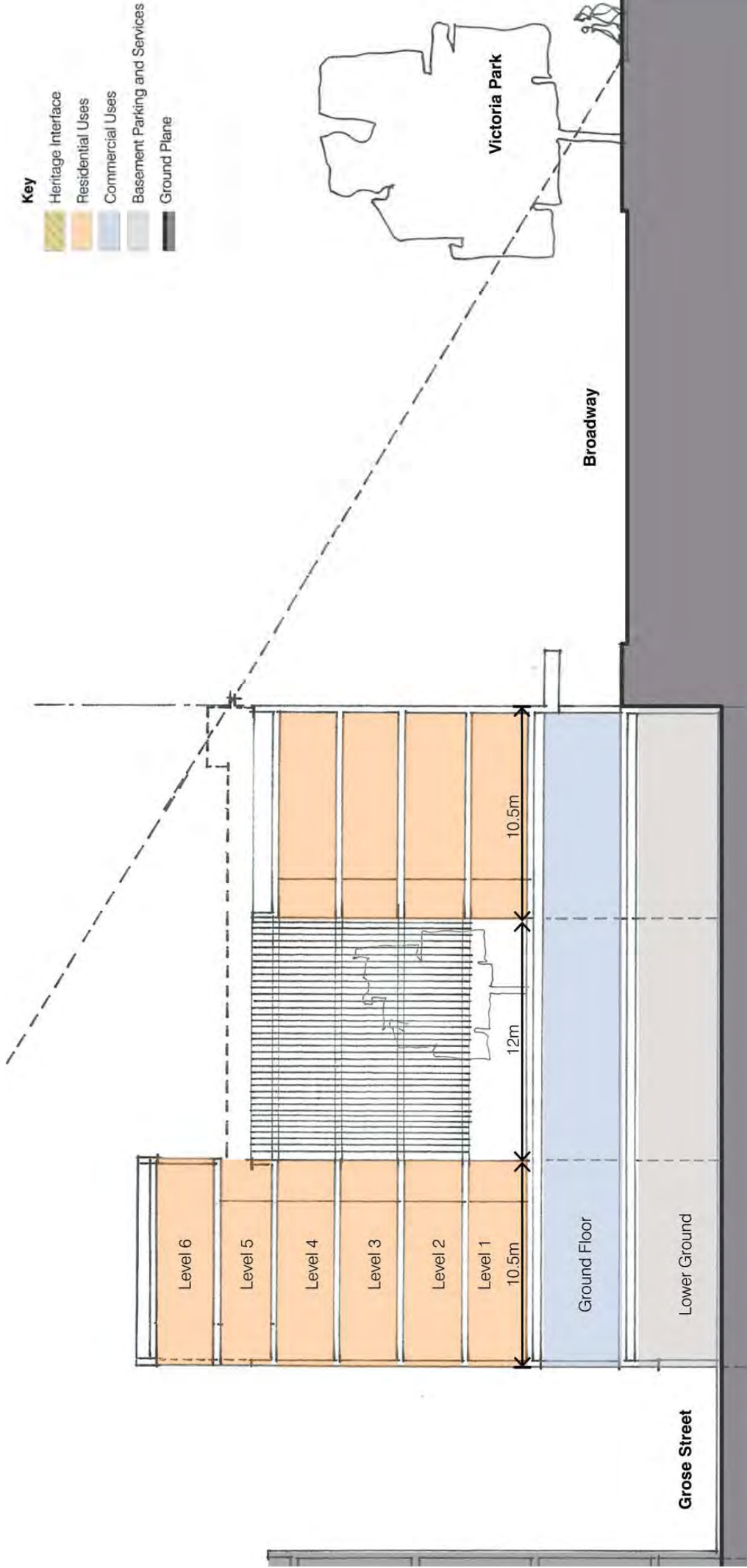

Option 3 – Commercial Ground Floor Plan (West)

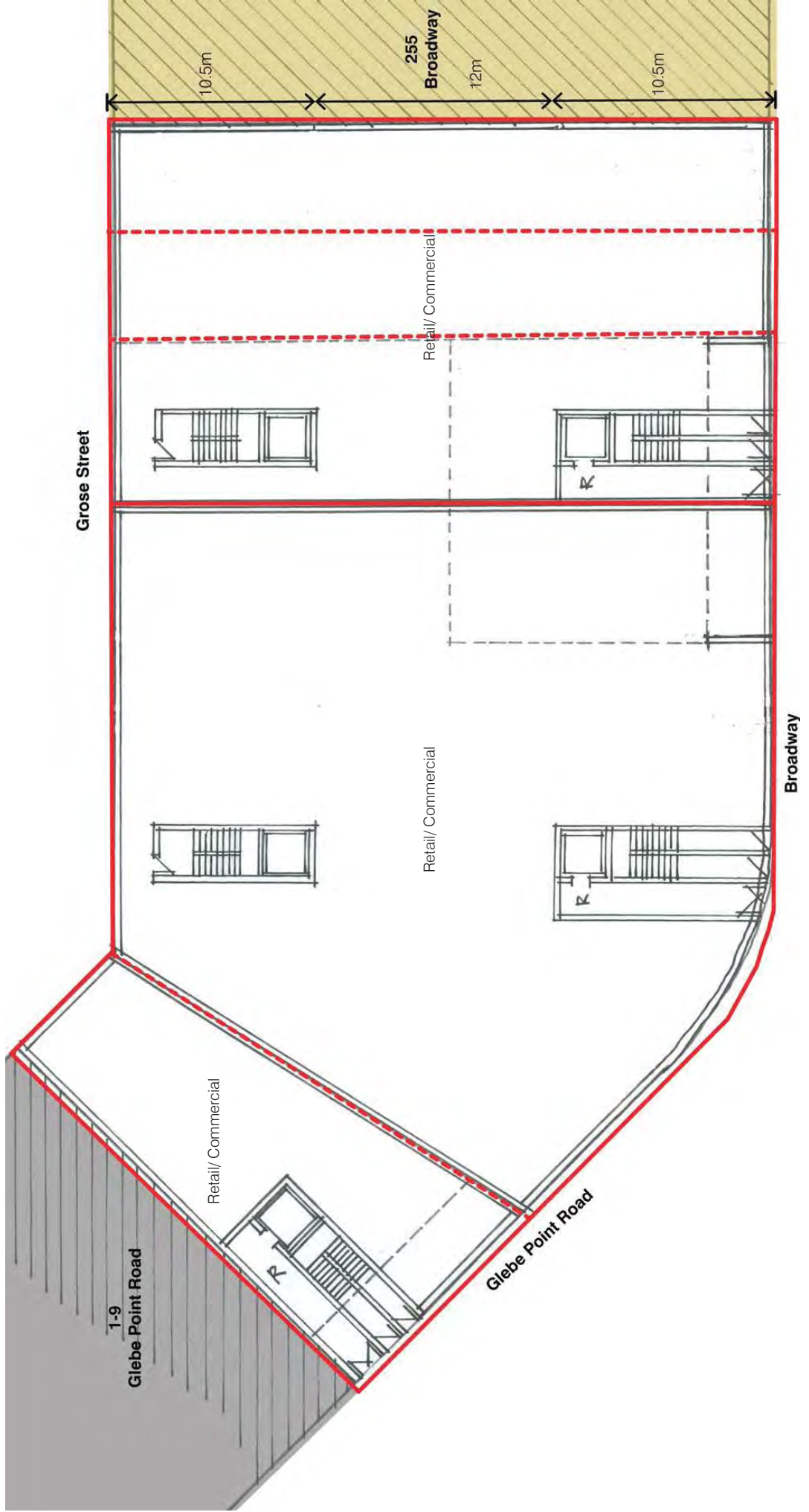

Option 3 – Commercial Ground Floor Plan (East)

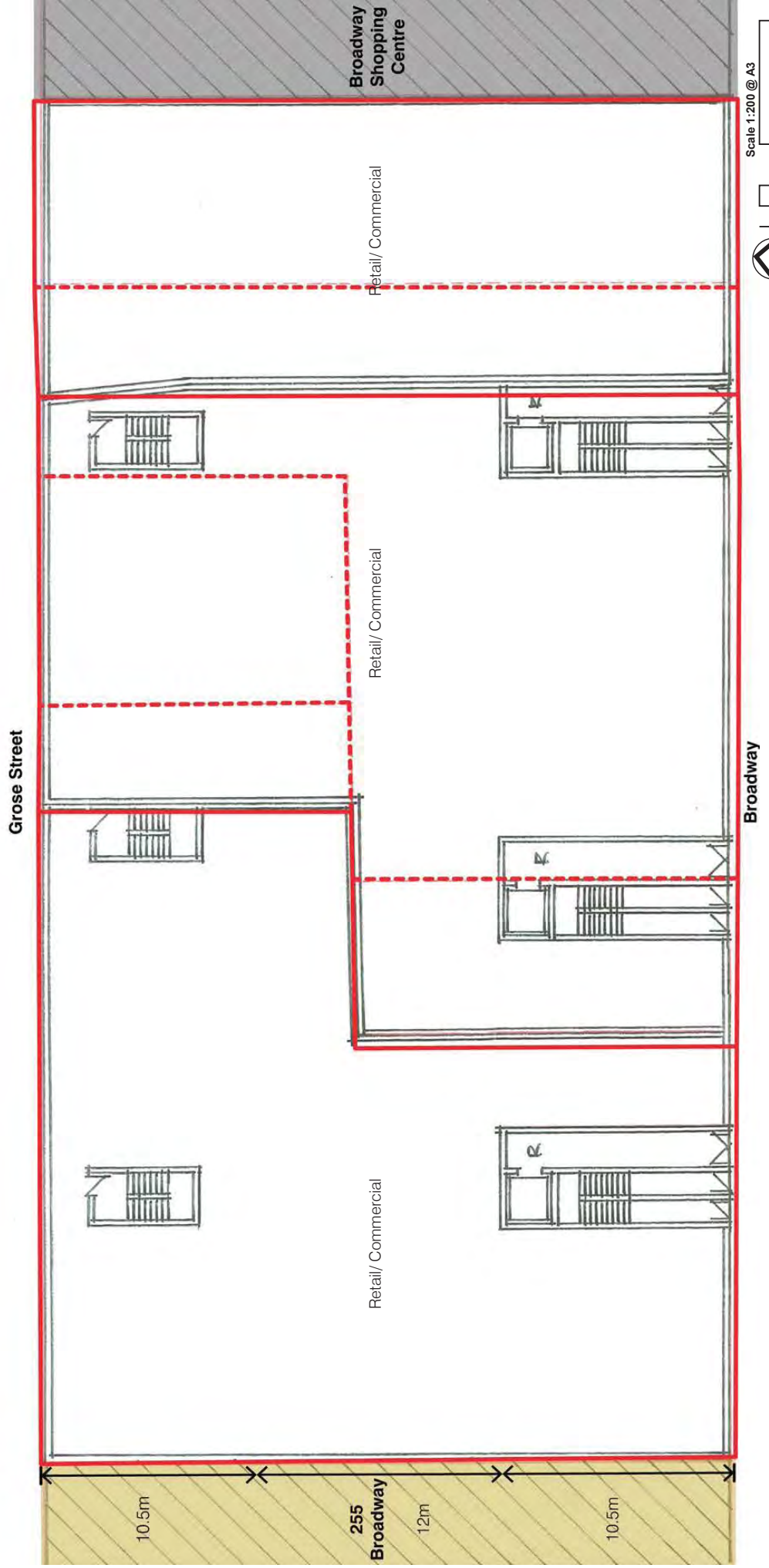

Option 3 – Typical and Upper Residential Floor Plan (West)

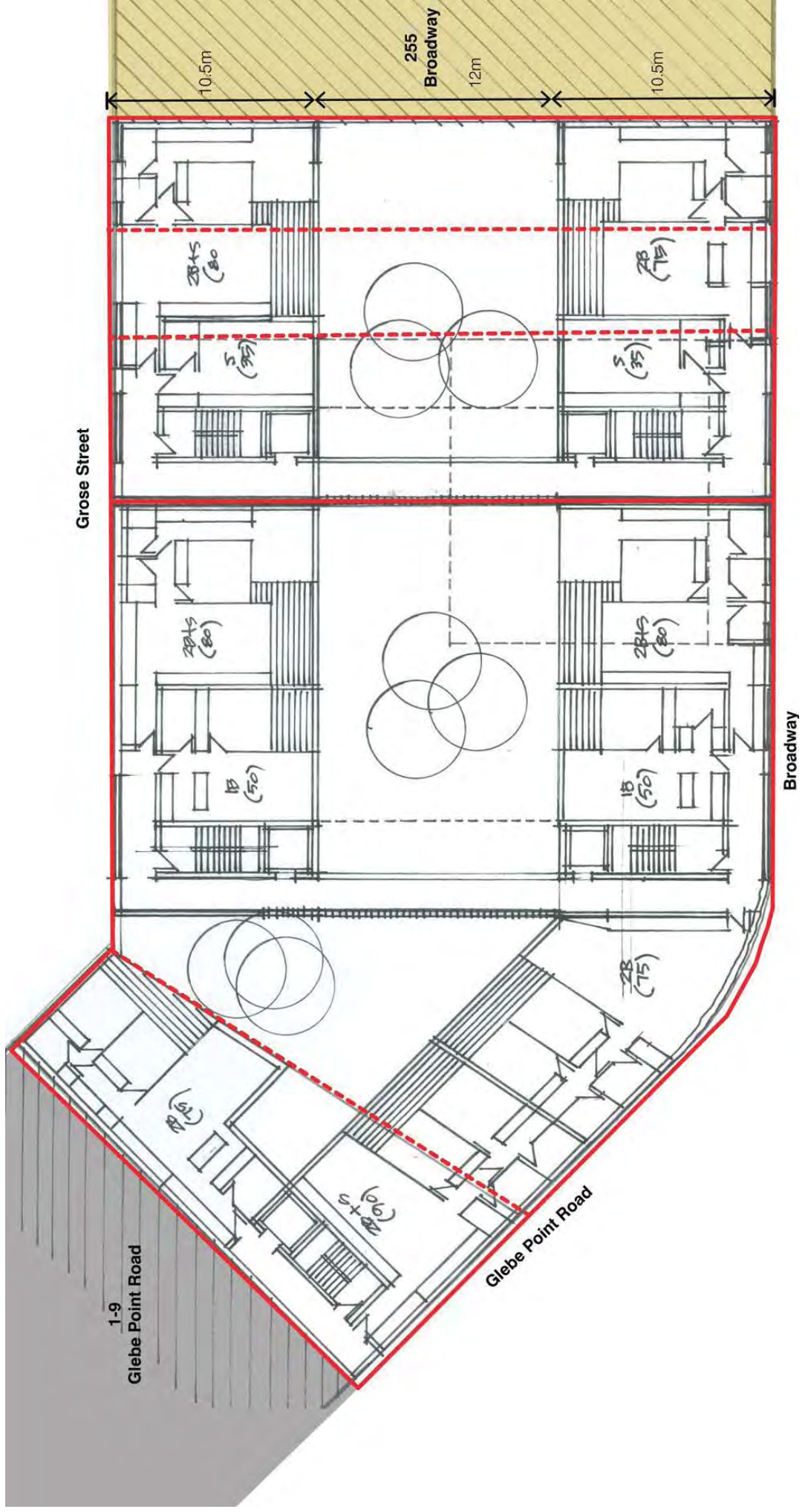

Option 3 – Typical and Upper Residential Floor Plan (East)

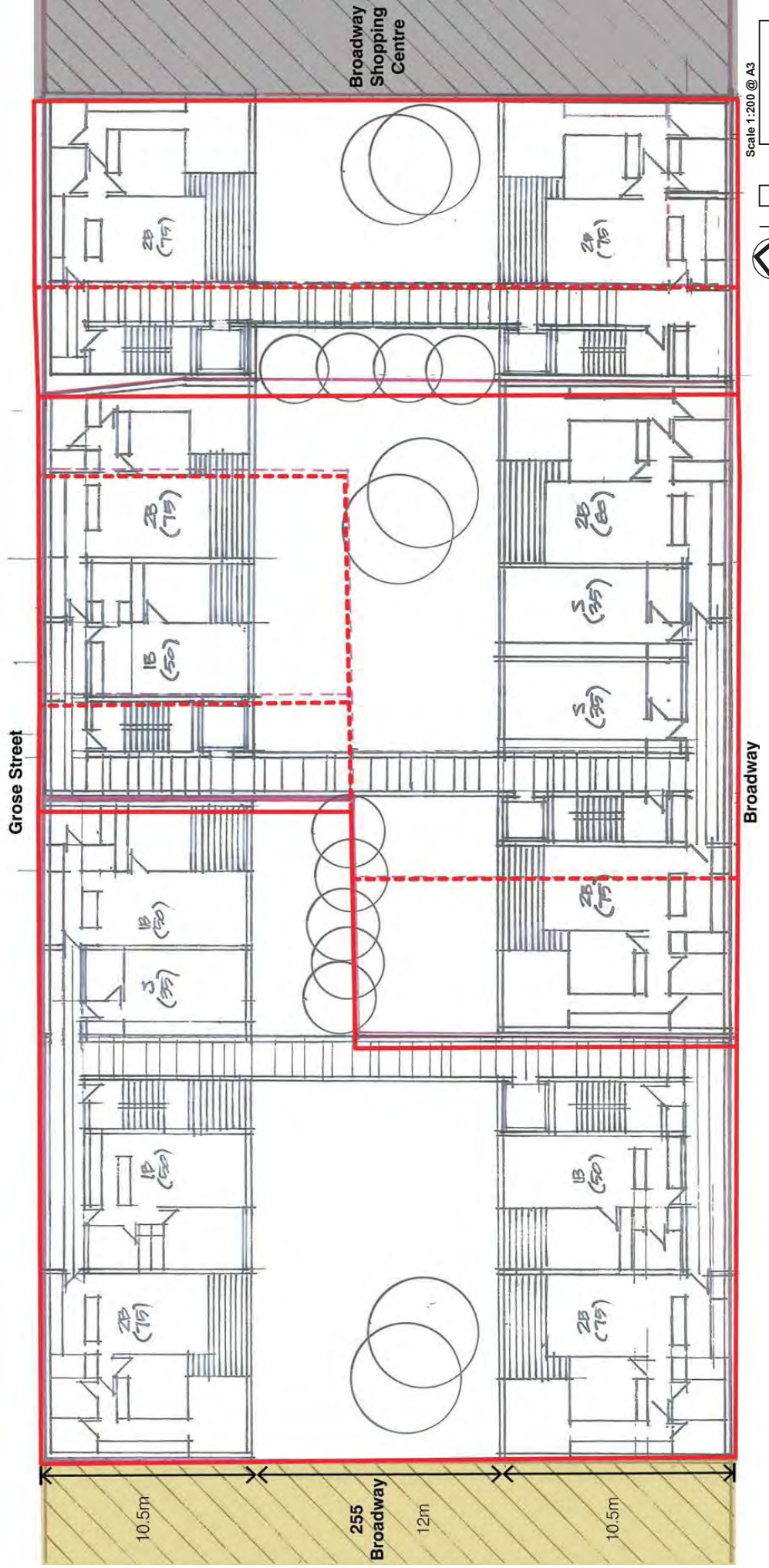

Option 3 – View Impact Analysis



Option 3 – View east along Broadway from Sydney University

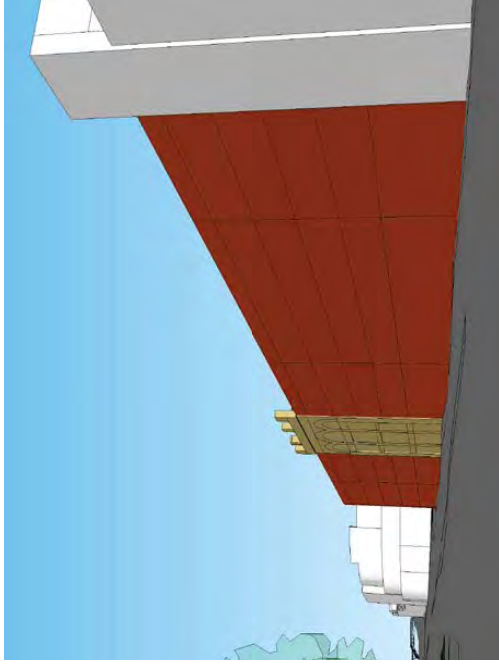

Option 3 – View north across Broadway from City Road

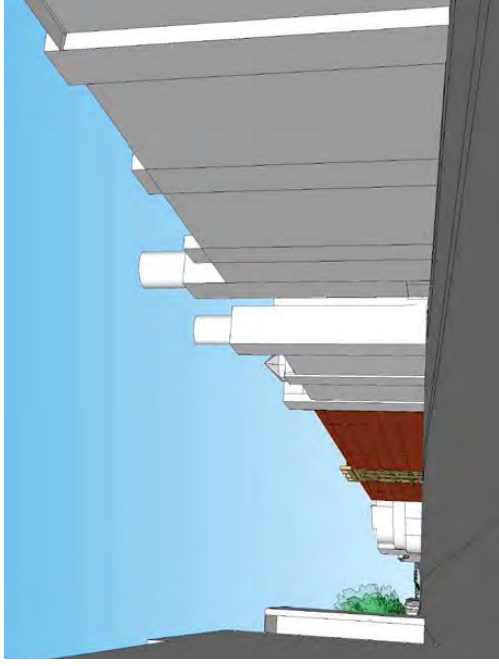

Option 3 – View west along Broadway from Buckland Street

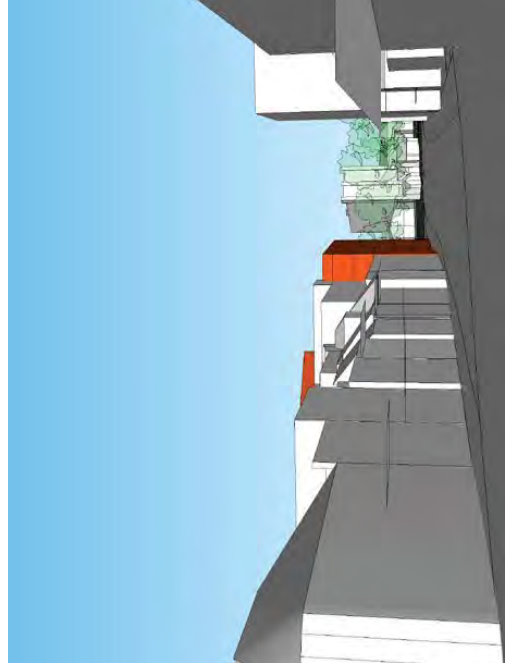

Option 3 – View south along Glebe Point Road



Option 3 – View of Broadway from the south side of Lake Northam, Victoria Park



Option 3 – View of Broadway from the south side of Victoria Park Pool

Option 3 – Summary

Public		Private
Advantages		
<ul style="list-style-type: none"> The coherent five storey street wall to Broadway creates visual continuity between the Broadway Shopping Centre, 255 Broadway, and University Hall. The five storey street wall curves around the corner to Glebe Point Road, creating a positive relationship with the University Hall building opposite, and a distinct 'threshold' entry space into Glebe. Overshadowing of Victoria Park is minimised. 		
Disadvantages		
<ul style="list-style-type: none"> Only 255 Broadway is retained as a heritage building – the other potential heritage elements are lost. Continuing the five storey street wall through to the end of the study area necessitates that another property (ideally 1-9 Glebe Point Road) provides a height transition from Broadway to Glebe Point Road. 		

Public		Private
Advantages		
<ul style="list-style-type: none"> The internal courtyard is almost completely enclosed by buildings, shielding this space and the apartments that front onto it from road noise and service noise. The taller Grose Street building offers a higher degree of residential amenity, with good solar access, ventilation, and district views available. 		
Disadvantages		
<ul style="list-style-type: none"> The Grose Street buildings rise several storeys above the Broadway Shopping Centre rooftop, exposing these apartments to noise from existing building services. The Grose Street buildings are located along the north side of the internal courtyard, and produce significant shadowing impacts upon the courtyard space and the apartments in the Broadway building. This significantly reduces amenity for a majority of apartments in the complex. The scale of enclosure of the internal courtyard may limit the effectiveness of natural ventilation for apartments that front onto this space. Depending on development order, some apartments are not shielded by road noise (due to dog leg lot configuration). 		

Conclusion

- The existing heritage building at 255 Broadway may be retained as a distinct and high quality component of the Broadway street frontage character.
- The visual prominence of the important Broadway and Glebe Point Road corner is increased by the continuous five storey street wall curving around the corner.
- The five storey street wall to Broadway and Glebe Point Road provides continuous protection of internal apartments from road noise.
- The nine storey Grose Street building impacts negatively on residential amenity as it may experience direct noise transmission from existing services on the Broadway Shopping Centre rooftop, while excessively overshadowing neighbouring residences and the internal courtyards to the south.

Indicative Yield Schedule

Level	225-229 Broadway			233-246 Broadway			247-253 Broadway			255 Broadway			257-261 Broadway			263-279 Broadway		
	BEA (m ²)	Commit GFA (m ²)	Res GFA (m ²)	BEA (m ²)	Commit GFA (m ²)	Res GFA (m ²)	BEA (m ²)	Commit GFA (m ²)	Res GFA (m ²)	BEA (m ²)	Commit GFA (m ²)	Res GFA (m ²)	BEA (m ²)	Commit GFA (m ²)	Res GFA (m ²)	BEA (m ²)	Commit GFA (m ²)	Res GFA (m ²)
Ground - Broadway	0	0	0	0	0	0	0	0	0	0	0	0	0	0	0	0	0	0
L01	295	446	224	224	543	801	540	641	641	406	641	641	406	643	318	300	1148	1033
L02	295	0	224	224	543	0	540	0	0	406	0	0	400	0	0	300	827	0
L03	295	0	224	224	543	0	540	0	0	406	0	0	400	0	0	300	827	0
L04	295	0	224	224	543	0	540	0	0	406	0	0	400	0	0	300	827	0
L05-06	158	446	1055	158	543	314	158	426	-	426	-	-	230	578	230	230	827	0
Subtotal																		
Total GFA	1500	1500	446	1500	2744	1943	1500	2308	2308	2049	2049	2308	2308	2007	1430	1430	3837	2804
Site Area	476	476	476	476	641	641	641	641	641	641	641	641	641	643	643	1148	1148	1148
FSR	3.2 :1	3.2 :1	3.1 :1	3.1 :1	3.3 :1	3.1 :1	3.3 :1	3.3 :1	3.3 :1	3.3 :1	3.3 :1	3.3 :1	3.3 :1	3.1 :1	3.1 :1	3.3 :1	3.3 :1	3.3 :1

Option 3 - Site Wide Key Summary	
Site Area	4,650
GFA Achieved	15,211
Aggregate FSR Achieved	3.27

Conversions from Built Envelope Area (BEA) to Gross Floor Area (GFA) vary depending upon proposed building use. Efficiency factors used are located on page 39 for reference.

3.5 Options 4 – Non-Residential Uses

Option 4 – Built Form Model

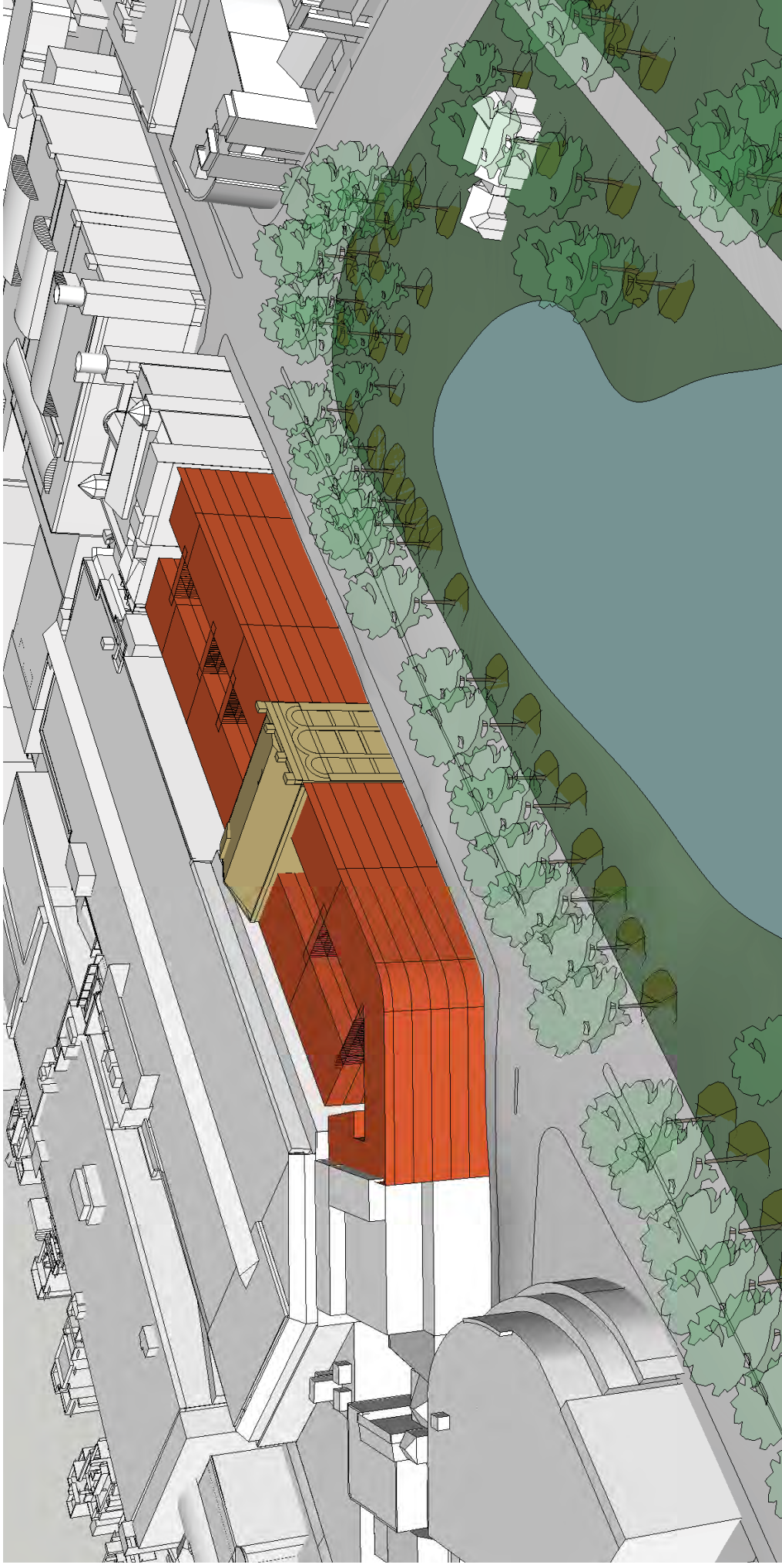

Option 4 – Typical Section

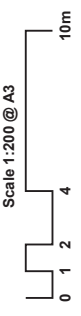
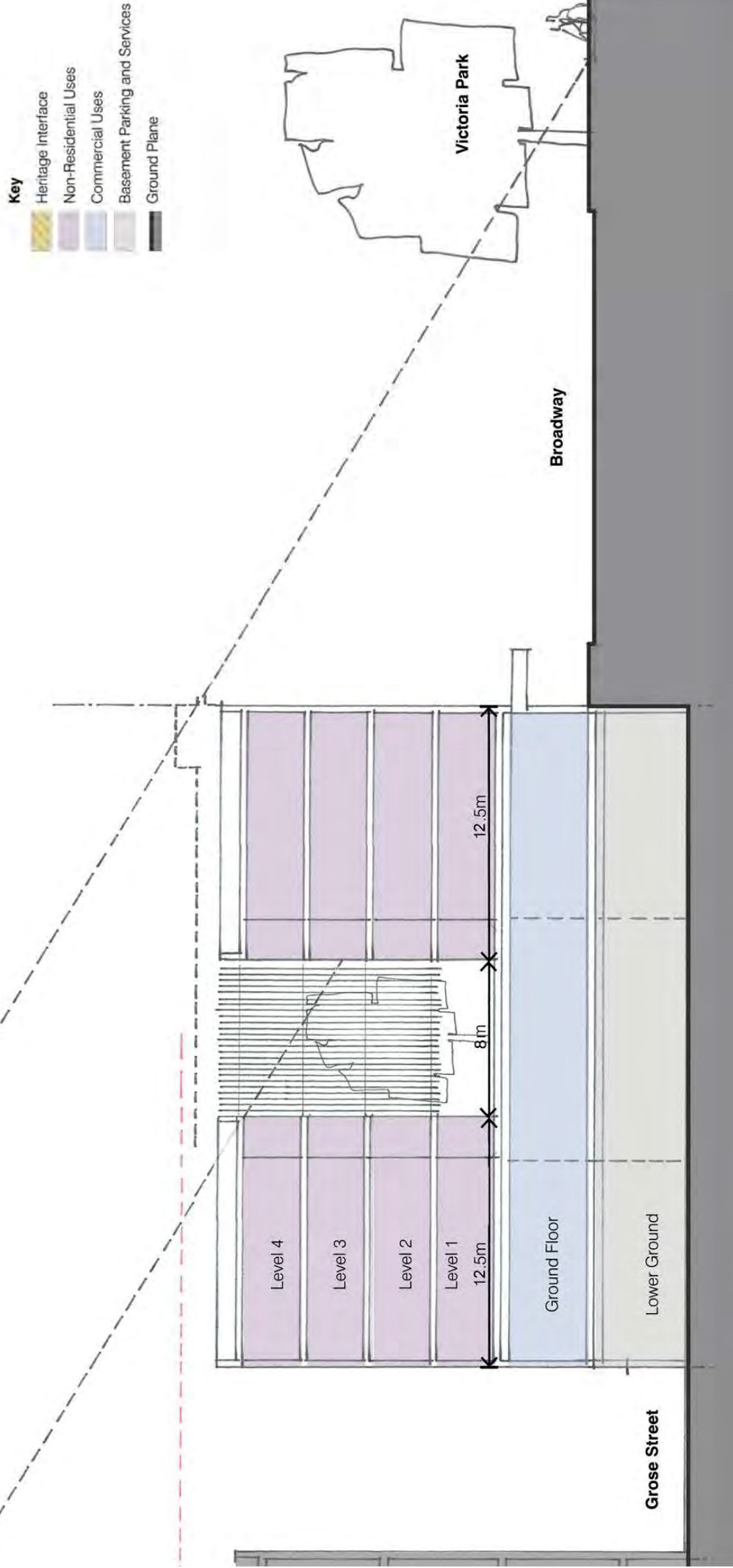

Option 4 – Commercial Ground Floor Plan (West)

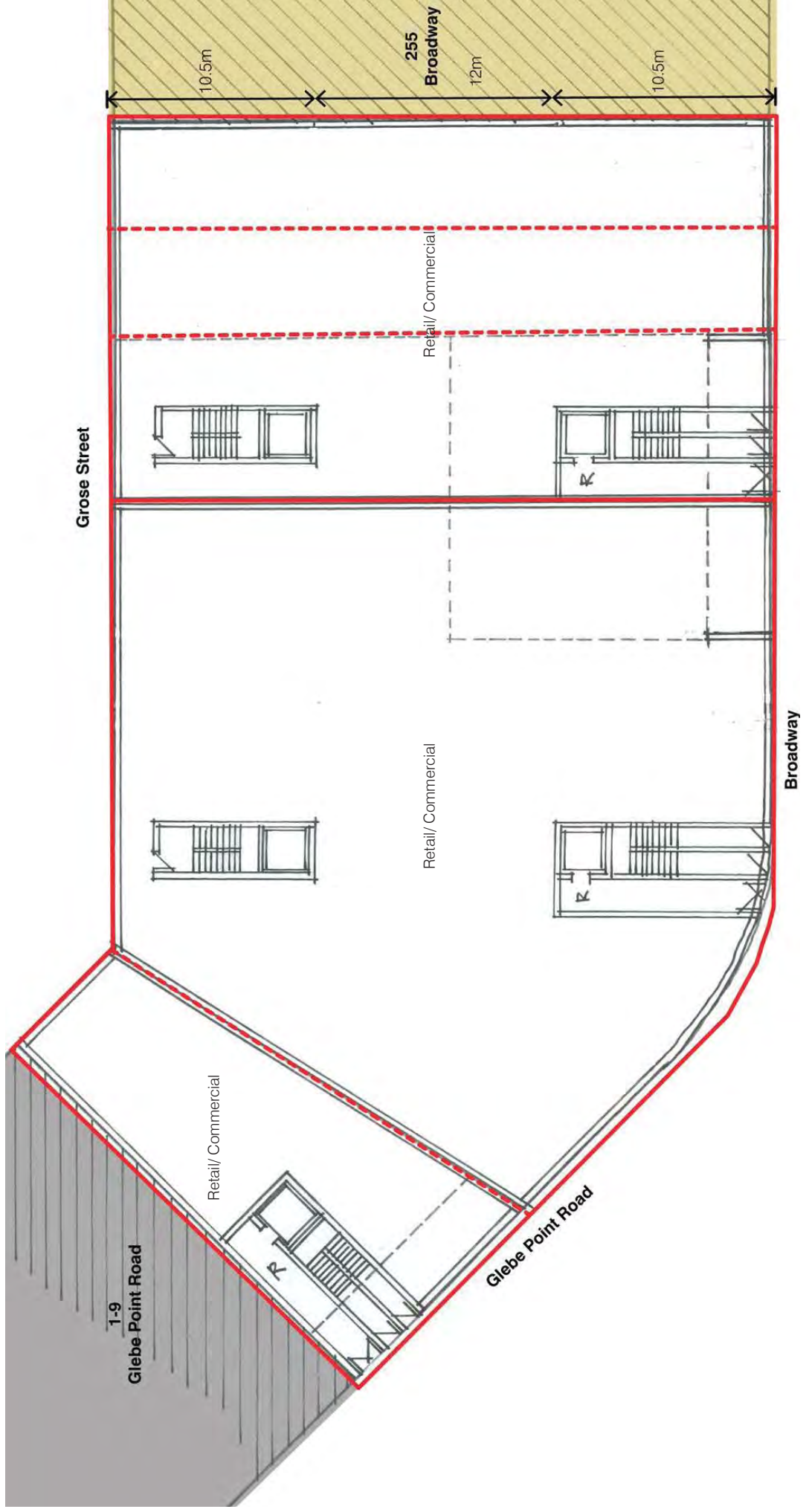

Option 4 – Commercial Ground Floor Plan (East)

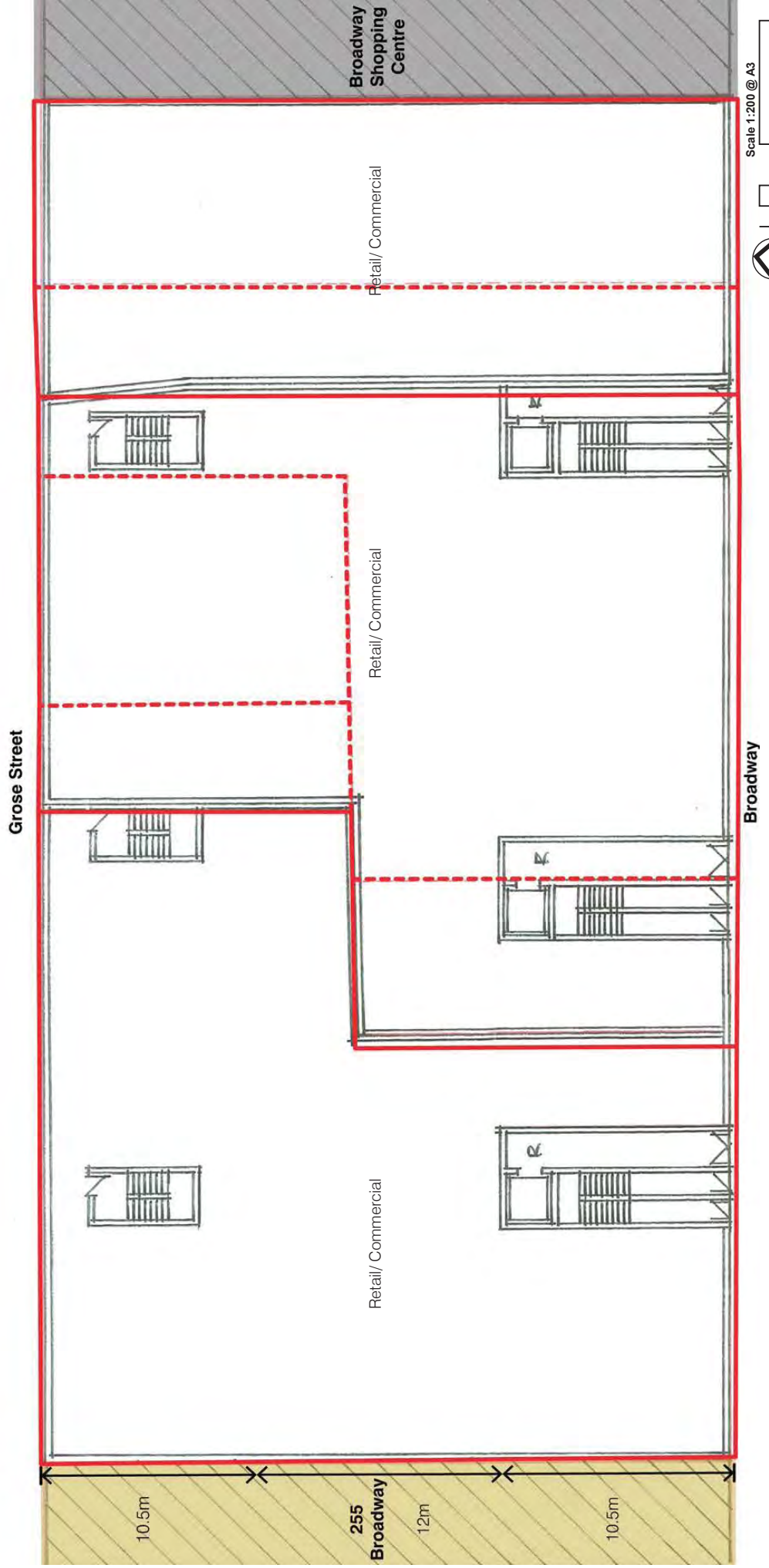

Option 4 – Typical and Upper Non-Residential Floor Plan (West)

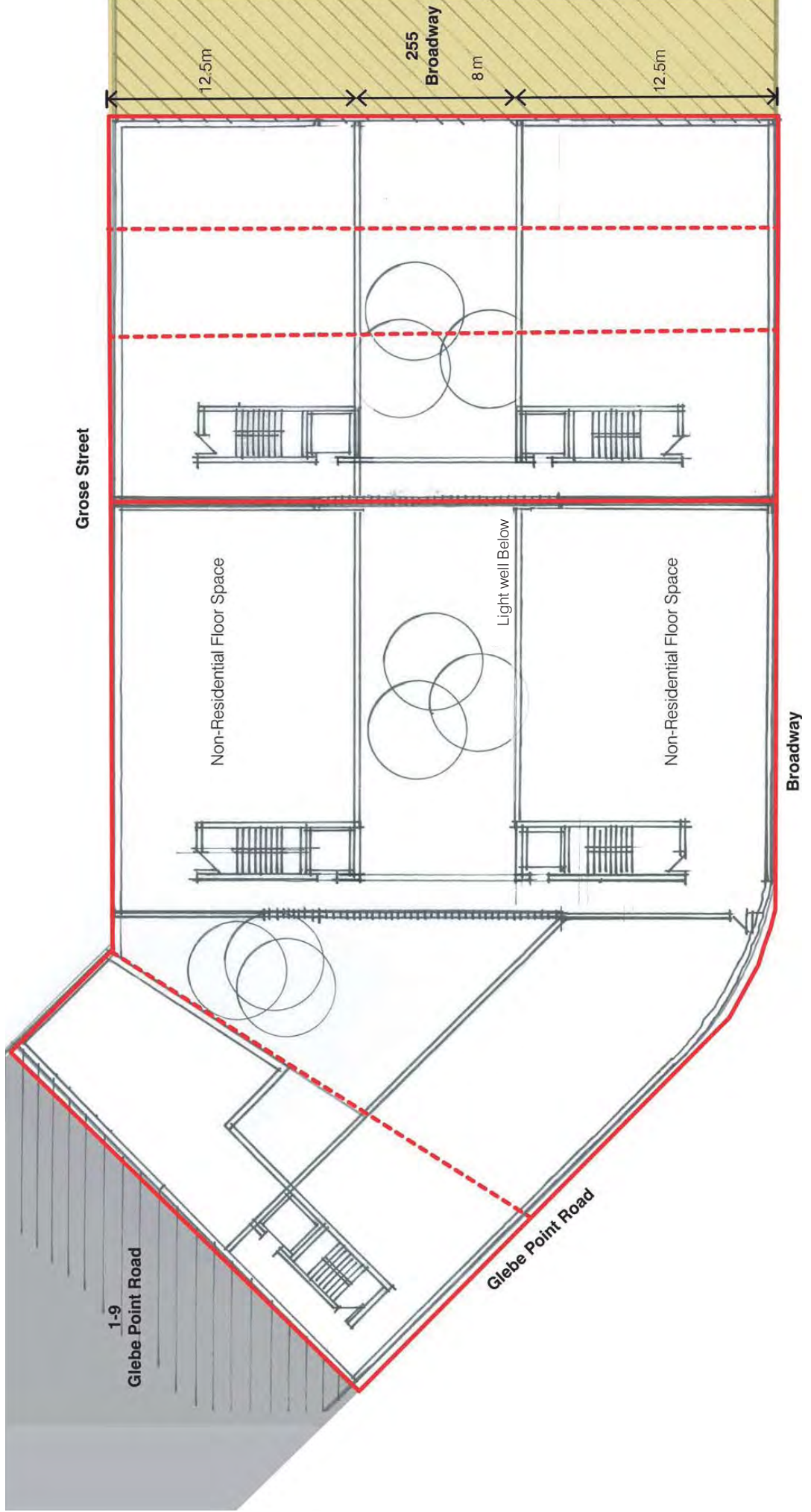

Option 4 – Typical and Upper Non-Residential Floor Plan (East)

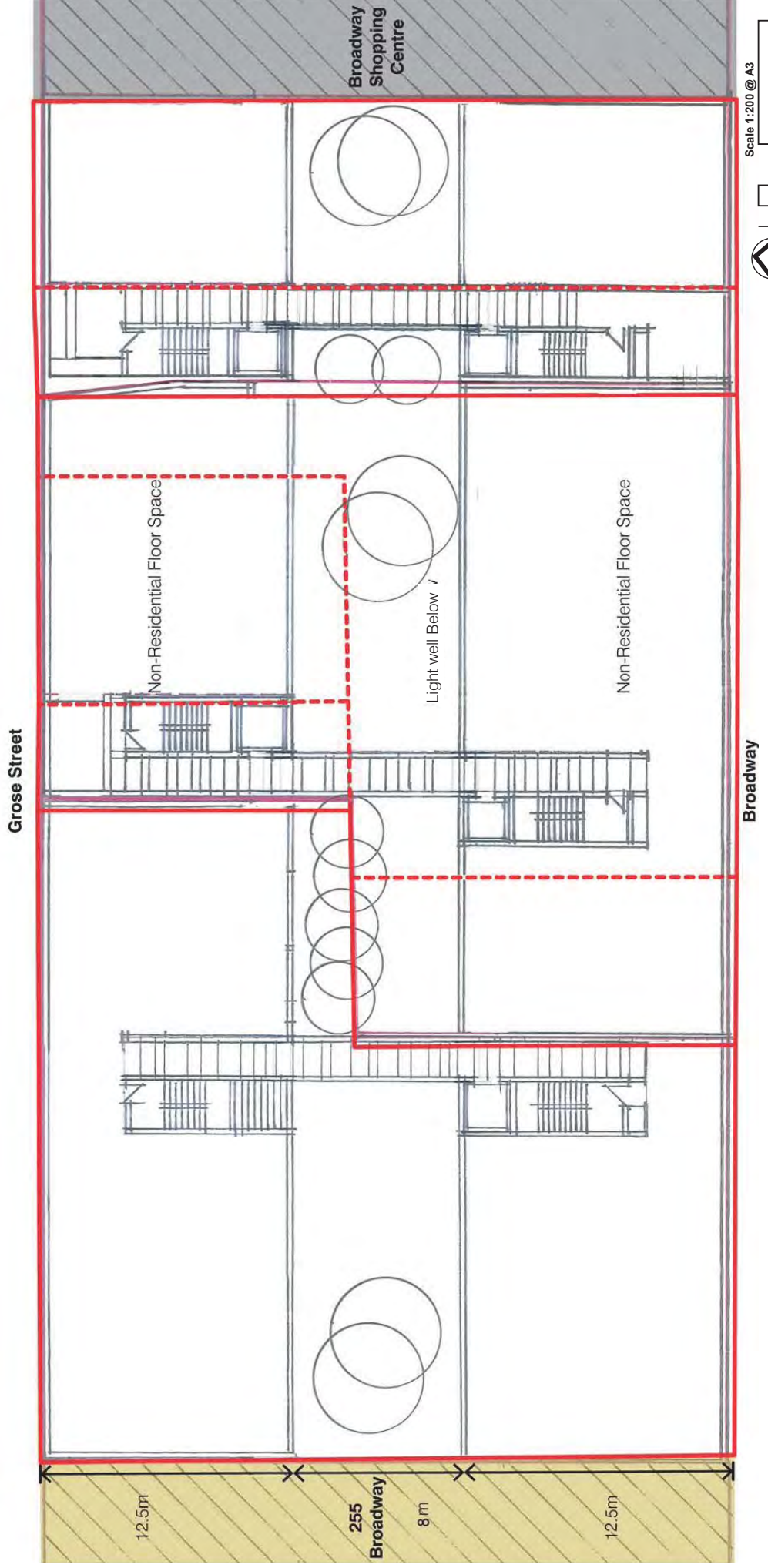

Option 4 – View Analysis

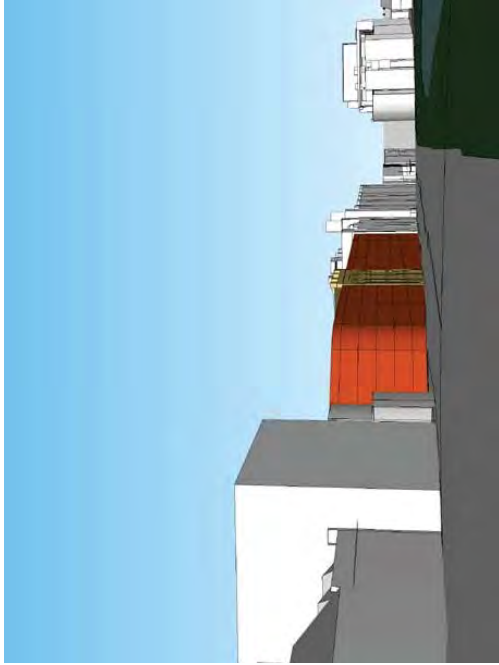

Option 4 – View east along Broadway from Sydney University

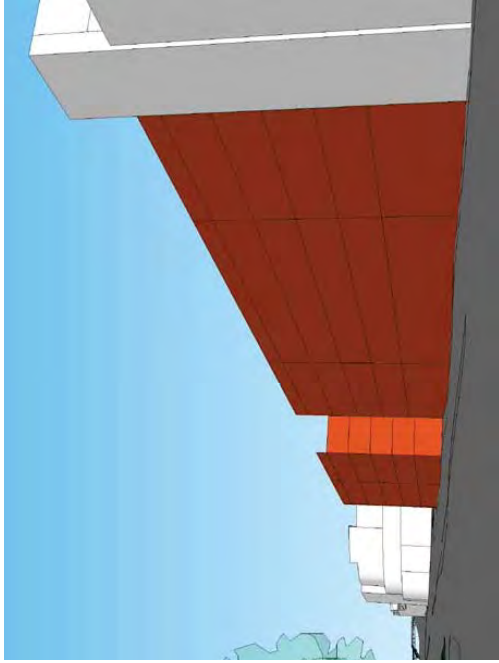

Option 4 – View north across Broadway from City Road

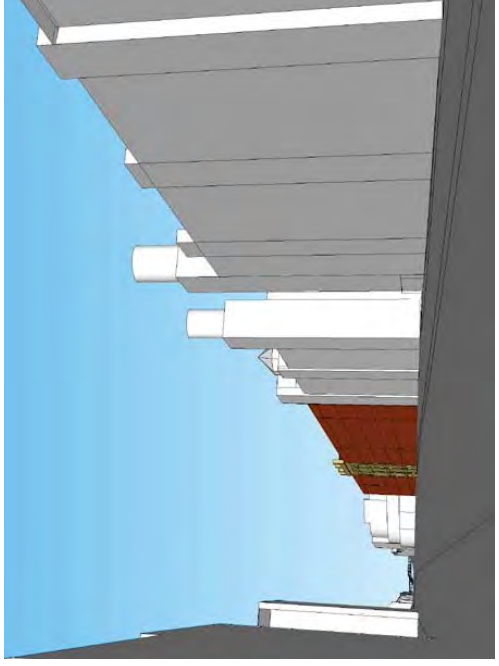

Option 4 – View west along Broadway from Buckland Street

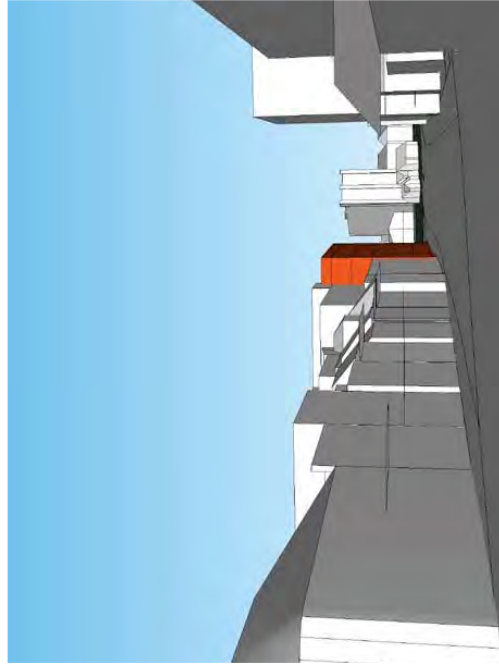

Option 4 – View south along Glebe Point Road



Option 4 – View of Broadway from the south side of Lake Northam, Victoria Park



Option 4 – View of Broadway from the south side of Victoria Park Pool

Option 4 - View Analysis (+2 storeys to Grose Street)



Option 4 - View east along Broadway from Sydney University

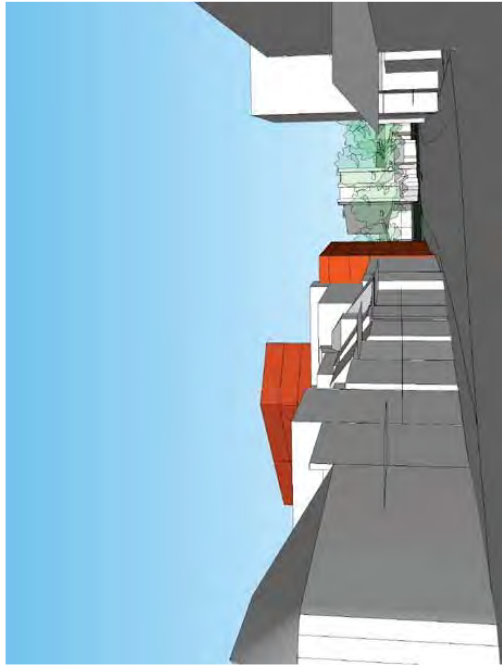

Option 4 - View south along Glebe Point Road

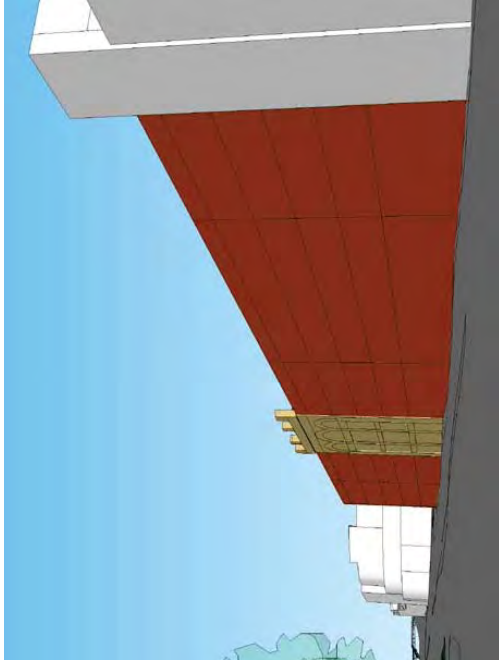

Option 4 - View north across Broadway from City Road



Option 4 - View of Broadway from the south side of Lake Northam, Victoria Park

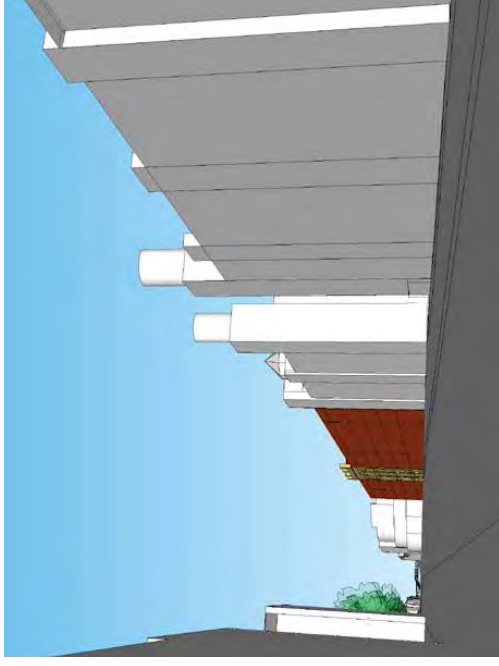

Option 4 - View west along Broadway from Buckland Street

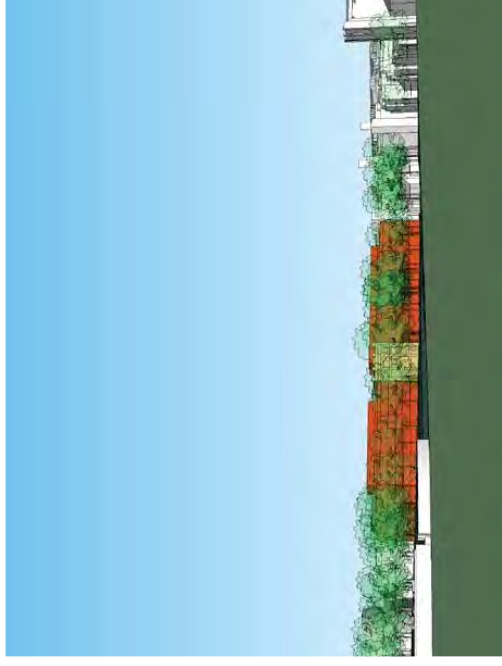

Option 4 - View of Broadway from the south side of Victoria Park Pool

Option 4 - View Analysis (+4 storeys to Grose Street)



Option 4 - View east along Broadway from Sydney University

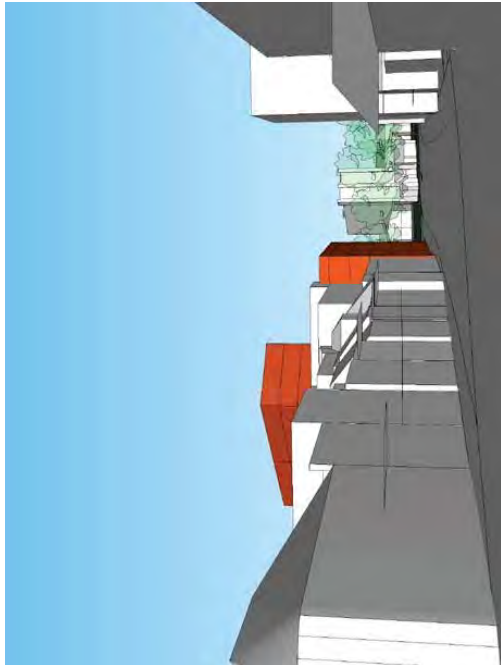

Option 4 - View south along Glebe Point Road

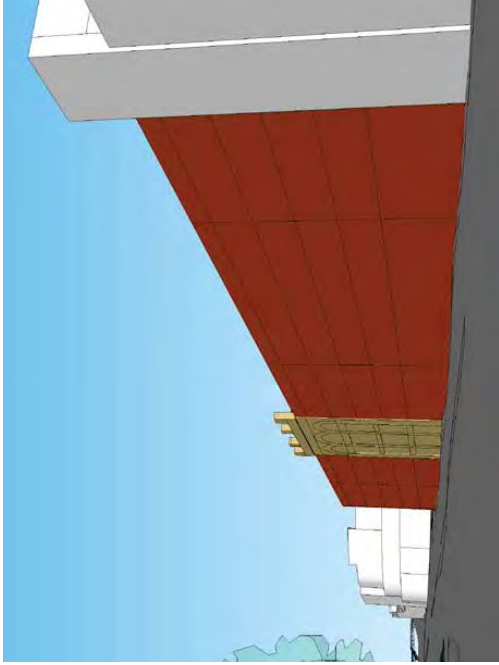

Option 4 - View north across Broadway from City Road



Option 4 - View of Broadway from the south side of Lake Northam, Victoria Park

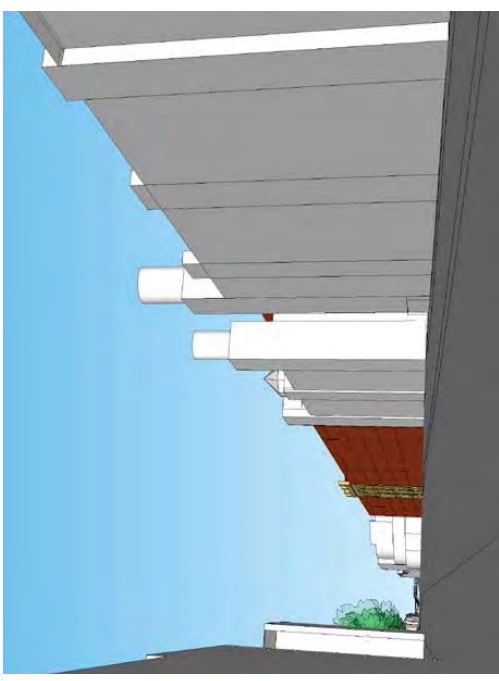

Option 4 - View west along Broadway from Buckland Street

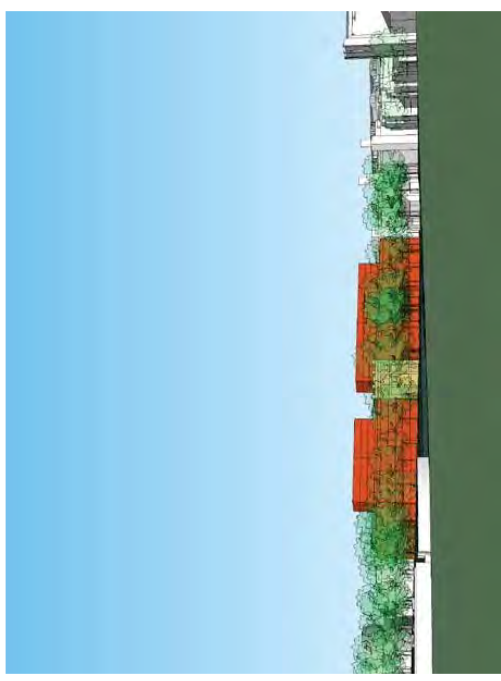

Option 4 - View of Broadway from the south side of Victoria Park Pool

Option 4 – Conclusion

- Non-residential uses may be encouraged on this site. These uses are less sensitive to noise from Broadway and from the Broadway Shopping Centre, and may offer opportunities for local employment, education, or other such functions that are highly appropriate for a local centre.
- The existing heritage building at 255 Broadway may be retained as a distinct and high quality component of the Broadway street frontage character.
- The visual prominence of the important Broadway and Glebe Point Road corner is increased by the continuous five storey street wall curving around the corner.
- The five storey street wall to Broadway and Glebe Point Road provides continuous protection of internal apartments from road noise.
- The universal limit to building height facilitates a high degree of residential amenity to apartments throughout the study area by sharing solar access and limiting noise ingress.
- The indicative visual study which tests an additional 2 and 4 storeys indicated in the option demonstrates that the height and bulk are visible when the site is viewed from Victoria Park and Glebe Point Road.

Indicative Yield Schedule

Option 4a (Student Housing) - Indicative Schedule of Areas

Level	225-229 Broadway			233-245 Broadway			255 Broadway			257-261 Broadway			263-273 Broadway		
	BEA (m ²)	Com/Ret (m ²)	Student GFA (m ²)	BEA (m ²)	Com/Ret (m ²)	Student GFA (m ²)	BEA (m ²)	Com/Ret (m ²)	Student GFA (m ²)	BEA (m ²)	Com/Ret (m ²)	Student GFA (m ²)	BEA (m ²)	Com/Ret (m ²)	Student GFA (m ²)
Ground - Broadway	493	446	0	891	802	0	641	577	642	578	1344	0	1148	1033	0
L01	360	0	292	650	0	455	482	641	480	336	0	336	907	0	636
L02	360	0	292	650	0	455	482	641	480	336	0	336	907	0	636
L03	360	0	292	650	0	455	482	641	480	336	0	336	907	0	636
L04	360	0	292	650	0	455	482	641	480	336	0	336	907	0	636
L05-06															
Subtotal		446	1008		802	1820		2308	0	578	1344		1033	3573	2540
Total GFA		1454			2622			2308		1922				1148	
Site Area		476			891			641		643				1148	
FSR		3.1 :1			2.9 :1			3.6 :1		3.0 :1				3.1 :1	

Option 4a - Site Wide Key Summary	4,650
Site Area	1,449
GFA Achieved	16,882
Appropriate FSR/Achieved	3.1:1

Option 4b (Commercial) - Indicative Schedule of Areas

Level	225-229 Broadway			233-245 Broadway			255 Broadway			257-261 Broadway			263-273 Broadway		
	BEA (m ²)	Com/Ret (m ²)	Student GFA (m ²)	BEA (m ²)	Com/Ret (m ²)	Student GFA (m ²)	BEA (m ²)	Com/Ret (m ²)	Student GFA (m ²)	BEA (m ²)	Com/Ret (m ²)	Student GFA (m ²)	BEA (m ²)	Com/Ret (m ²)	Student GFA (m ²)
Ground - Broadway	493	446	0	891	802	0	641	577	642	578	1344	0	1148	1033	0
L01	360	324	0	650	595	0	482	641	480	336	0	336	907	816	0
L02	360	324	0	650	595	0	482	641	480	336	0	336	907	816	0
L03	360	324	0	650	595	0	482	641	480	336	0	336	907	816	0
L04	360	324	0	650	595	0	482	641	480	336	0	336	907	816	0
L05-06															
Subtotal		1742	0		3142	0		2308	0	578	1344		1148	4298	0
Total GFA		1742			3142			2308		1922				4298	
Site Area		476			891			641		643				1148	
FSR		3.7 :1			3.5 :1			3.6 :1		3.0 :1				3.7 :1	

Option 4b - Site Wide Key Summary	4,650
Site Area	1,449
GFA Achieved	16,882
Appropriate FSR/Achieved	3.6:1

Option 4c (Hotel) - Indicative Schedule of Areas

Level	225-229 Broadway			233-245 Broadway			255 Broadway			257-261 Broadway			263-273 Broadway		
	BEA (m ²)	Com/Ret (m ²)	Student GFA (m ²)	BEA (m ²)	Com/Ret (m ²)	Student GFA (m ²)	BEA (m ²)	Com/Ret (m ²)	Student GFA (m ²)	BEA (m ²)	Com/Ret (m ²)	Student GFA (m ²)	BEA (m ²)	Com/Ret (m ²)	Student GFA (m ²)
Ground - Broadway	493	396	0	891	713	0	641	577	642	514	1148	0	1148	918	0
L01	360	288	0	650	520	0	482	641	480	384	0	384	907	726	0
L02	360	288	0	650	520	0	482	641	480	384	0	384	907	726	0
L03	360	288	0	650	520	0	482	641	480	384	0	384	907	726	0
L04	360	288	0	650	520	0	482	641	480	384	0	384	907	726	0
L05-06															
Subtotal		1548	0		2793	0		2308	0	2062	1344			3821	0
Total GFA		1548			2793			2308		2062				3821	
Site Area		476			891			641		643				1148	
FSR		3.3 :1			3.1 :1			3.6 :1		3.2 :1				3.3 :1	

Option 4c - Site Wide Key Summary	4,650
Site Area	1,449
GFA Achieved	15,263
Appropriate FSR/Achieved	3.2:1

Conversions from Built Envelope Area (BEA) to Gross Floor Area (GFA) vary depending upon proposed building use. Efficiency factors used are located on page 39 for reference.

3.6 Shadow Analysis

Existing Built Form

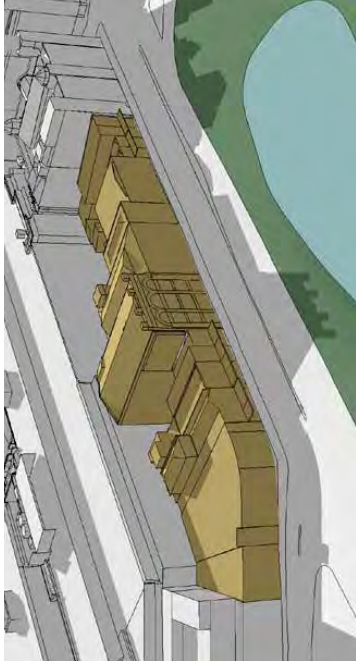

June 21 9am

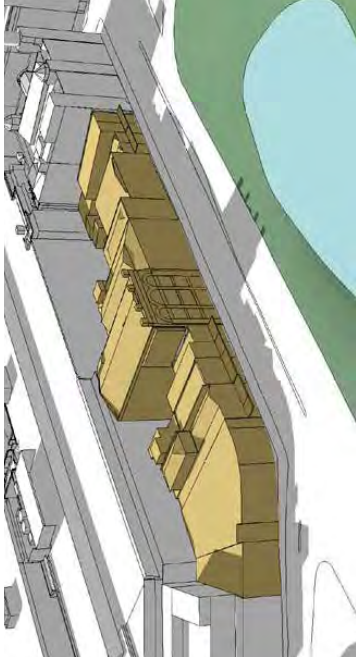

June 21 12noon



June 21 3pm

Shadow Analysis Considerations

- The heritage-listed Victoria Park features a row of large trees along the Broadway edge, as well as a variety of well-maintained garden beds, a lake, and grassy open spaces. Overshadowing impacts upon this public open space is limited to 255 Broadway. Overshadowing occurs along the park edge where significant fig trees are located and away from usable lawn areas.
- The subject site does not present any significant overshadowing impacts upon surrounding properties.

Option 1

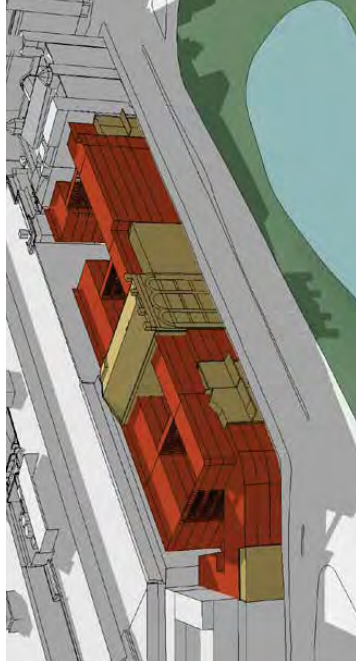

June 21 9am

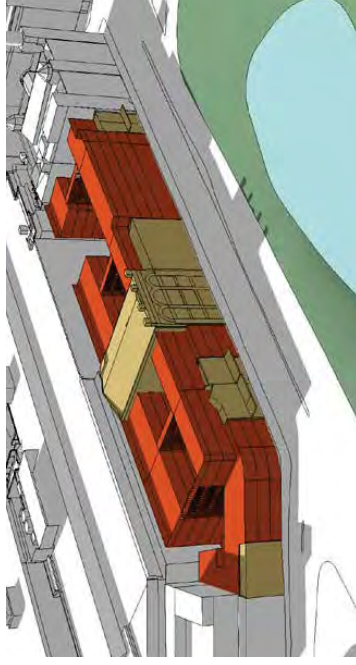

June 21 12noon

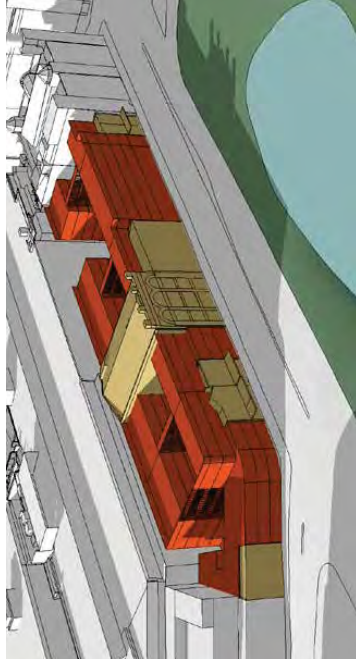

June 21 3pm

Option 1 Shadow Analysis Considerations

- Shadowing impacts from this option upon Victoria Park are similar to those of the existing building at 255 Broadway. The shadowing of the public domain is largely on the street reserve. Overshadowing of the park is limited to early and late hours of the day around the winter solstice, and occurs along the park edge where significant fig trees are located and away from usable lawn areas.
- Approximately half the space in the internal courtyards is overshadowed in winter, while residences facing the courtyard and residences facing Grose Street all receive extensive solar access.

Option 2

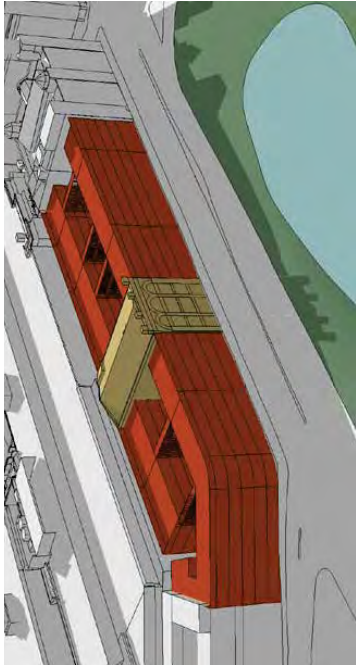

June 21 9am

Option 2 and 4 Shadow Analysis Considerations

- Shadowing impacts under Options 2 are alike those of Option 1.

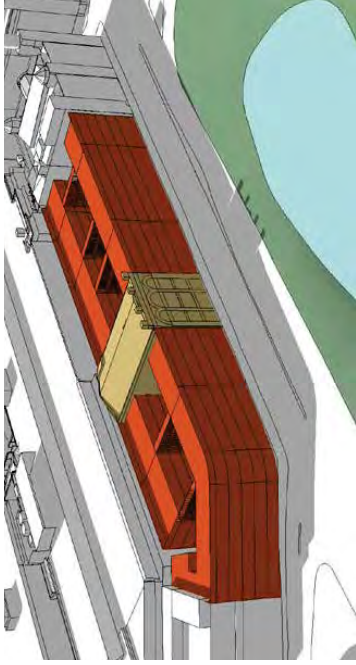

June 21 12noon

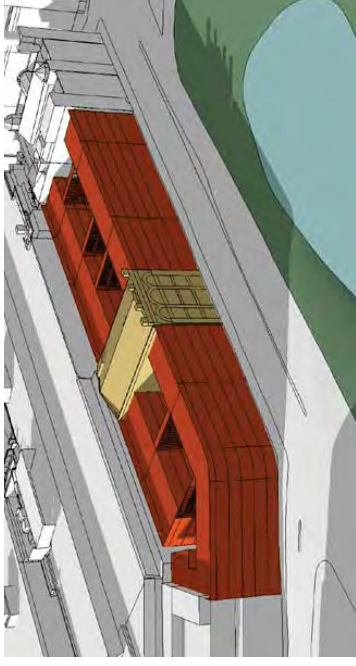

June 21 3pm

Option 3

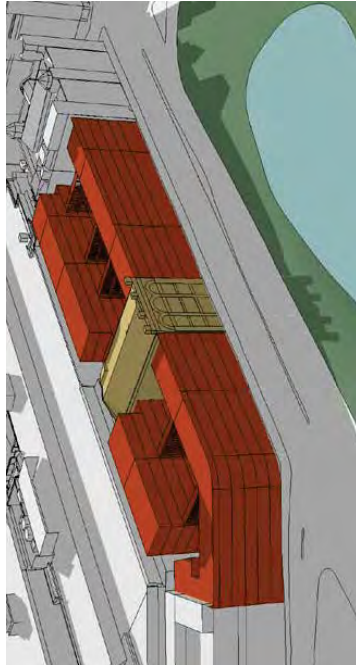

June 21 9am

Option 3 Shadow Analysis Considerations

- Shadowing impacts on Victoria Park in Option 3 are largely alike those in Options 1 and 2. The reason for this is that the seven storey Grosse Street buildings are not tall enough to increase overshadowing of Victoria Park. The five storey street wall along Broadway remains the primary shadowing feature to the north of the park.
- The seven storey Grosse Street buildings (with a six storey frontage to the internal courtyards) significantly increase overshadowing impacts upon the courtyard spaces as well as upon the proposed residences along Broadway.

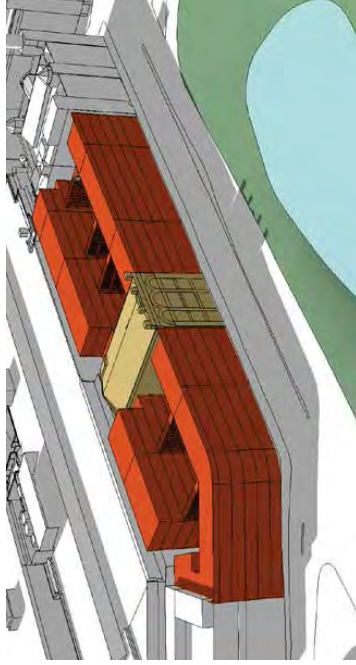

June 21 12noon

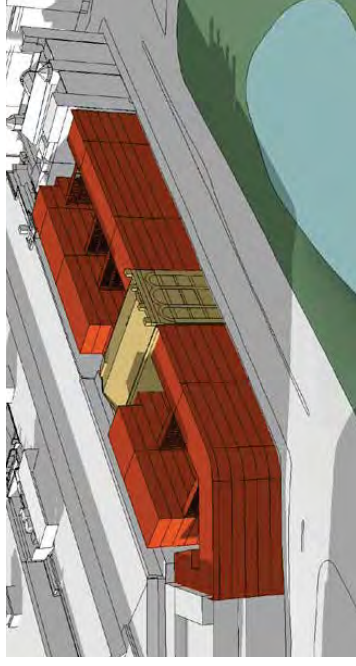

June 21 3pm

Option 4

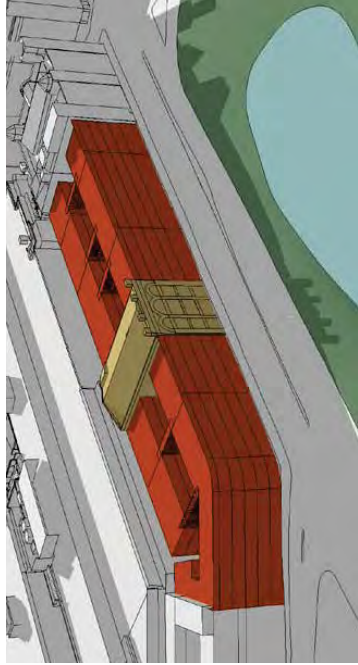

June 21 9am

Option 4 Shadow Analysis Considerations

- Shadowing impacts from this option upon Victoria Park are similar to those in Option 1. The shadowing of the public domain is largely on the street reserve. Overshadowing of the park is limited to early and late hours of the day around the winter solstice, and occurs along the park edge where significant fig trees are located and away from usable lawn areas.
- The light wells receive some sun in winter, while the rearward portion of the buildings along Grose Street all receive extensive solar access.

Option 4 (+2 storeys to Grose Street)

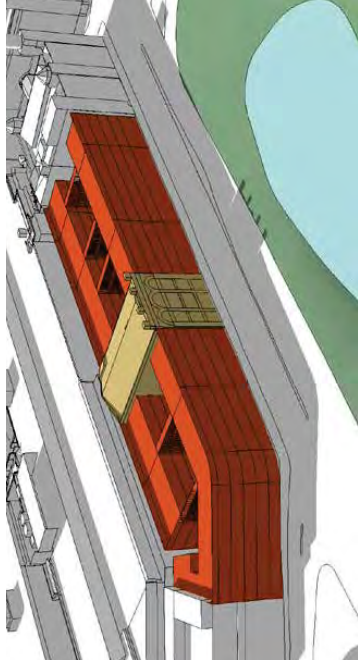

June 21 12noon

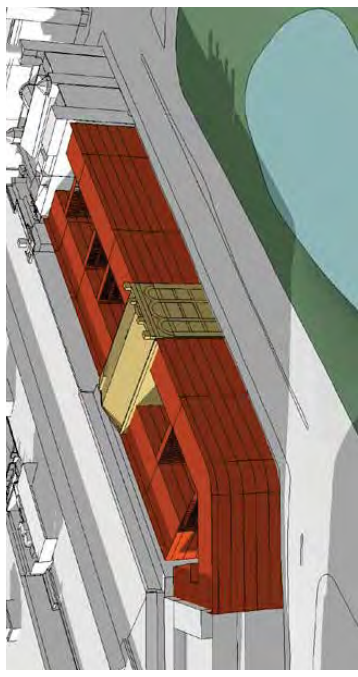

June 21 3pm

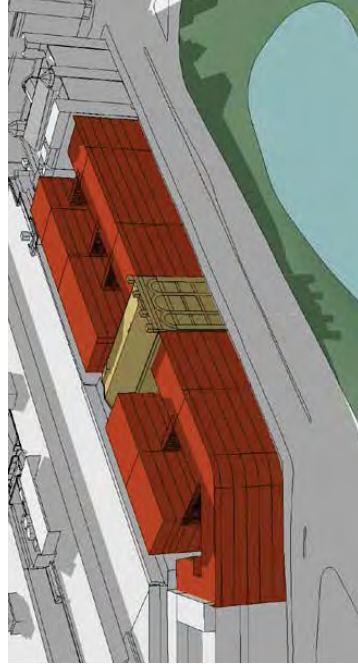

June 21 9am

Option 4 (2+ Storeys to Grose Street) Shadow Analysis Considerations

- Shadowing impacts on Victoria Park in this option are largely alike those in Options 1 and 2 and 3. The reason for this is that the seven storey Grose Street buildings are not tall enough to increase overshadowing of Victoria Park. The five storey street wall along Broadway remains the primary shadowing feature to the north of the park.
- The seven storey Grose Street buildings (with a six storey frontage to the internal light well) significantly increases the overshadowing impacts upon the non residential spaces adjacent the light well.

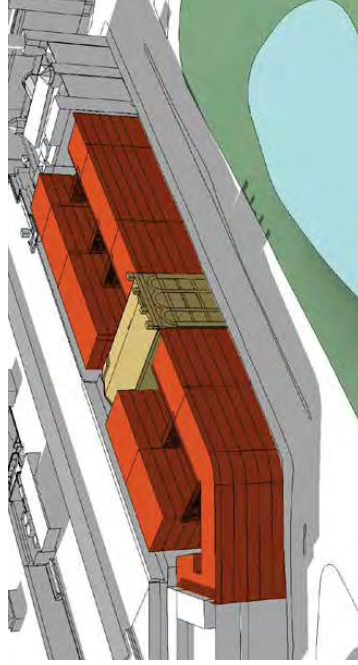

June 21 12noon

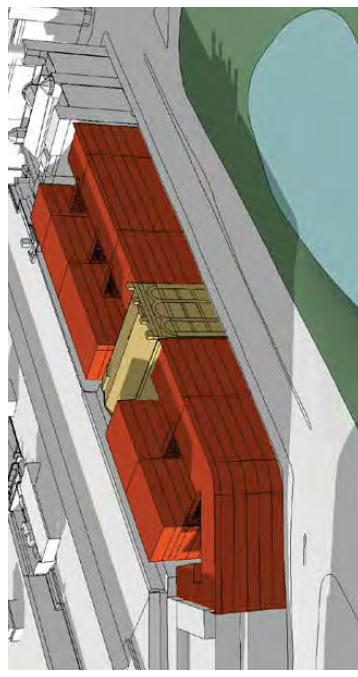

June 21 3pm

Option 4 (+4 storeys to Grose Street)

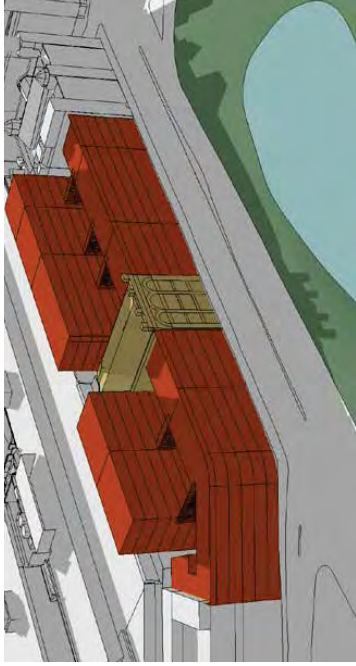

June 21 9am

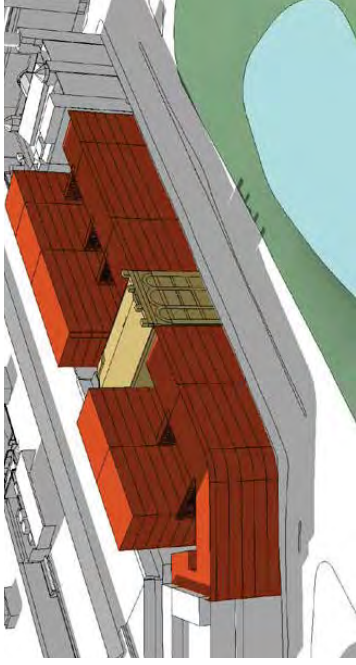

June 21 12noon

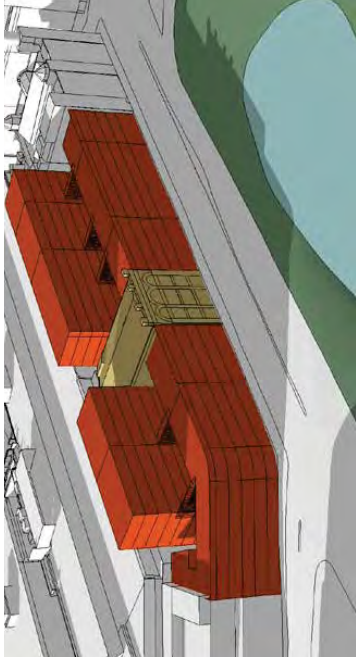

June 21 3pm

Option 4 (4+ Storeys to Grose Street) Shadow Analysis Considerations

- Shadowing impacts on Victoria Park in this option are largely alike those in Options 1 to 3 and Option 4 (+2 Storeys). The reason for this is that the seven storey Grose Street buildings are not tall enough to increase overshadowing of Victoria Park. The five storey street wall along Broadway remains the primary shadowing feature to the north of the park.
- The increased height of Grose Street buildings (with an eight storey frontage to the internal light wells) increases the overshadowing impacts upon the non residential spaces facing the light well more so than in Option 4 (2+ Storeys)

3.7 Public Interface Analysis

The Broadway – Glebe Point Road Corner



A Significant Corner

The avenue of trees and line of buildings that align Broadway between City Road and the University of Sydney are distinctive elements in the local urban landscape. Within this context, the Glebe Point Road intersection with Broadway has a dual function:

- As a landmark on the journey along Broadway, and
- As a gateway entrance into Glebe.

Streetscape Considerations

Developments around the Broadway / Glebe Point Road corner must recognise and respond to the character elements of both places. This involves a gradation between the taller and denser Broadway area to the shorter, greener, and more fine grained nature of Glebe.

Urban Design Strategies

There are two important roles that this corner plays in linking Broadway with Glebe Point Road:

- Turning the corner, with a clear relationship to the curvaceous University Hall building on the opposite corner to be further enhanced.
- Transitioning in height from five to two storeys. (This step may be positioned on Glebe Point Road, at the corner, or facing Broadway).

The built forms on this corner may also contribute architectural gestures to Broadway and to Glebe Point Road; an opportunity that may be explored at a later stage in the design process.

5 Storey Street Frontage to Broadway, 3 Storey Street Frontage to Glebe Point Road



View east along Broadway from Sydney University

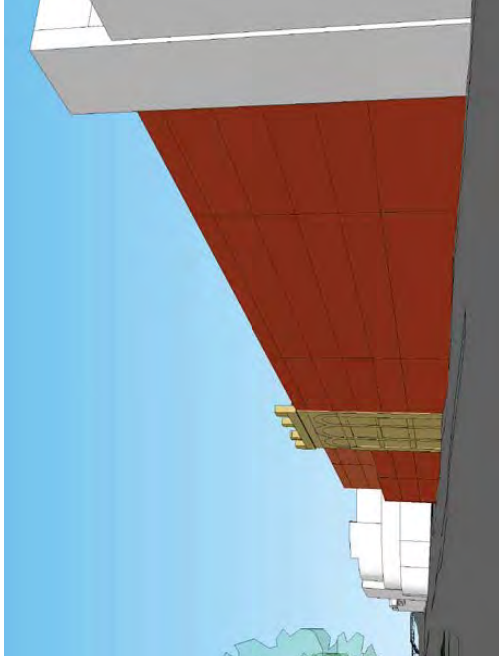

View north across Broadway from City Road

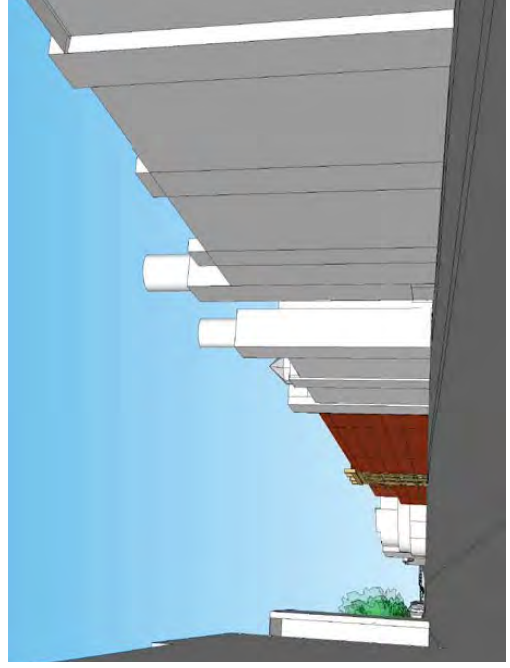

View west along Broadway from Buckland Street



View south along Glebe Point Road

Broadway

- The heritage building of 255 Broadway is utilised to provide definition between the vertical street wall (bright orange) and the setback street wall (light orange), where the fourth and fifth storeys are setback 3m.
- The sense of opening to Glebe Point Road is revealed in the Broadway facade by the setback fourth and fifth storeys to the west of 255 Broadway – even before the opening to Glebe Point Road is fully revealed from the viewer's position.

Street Corner

- The shape of the corner lacks clarity, as the first three storeys turn a rounded corner, while the top two setback storeys turn a sharper corner. This varied corner profile creates a weak counterpoint to the University Hall building, but accentuates University Hall and 255 Broadway buildings.

Height Transition

- The step is located right on the corner, and a three storey street wall is established leading into Glebe Point Road, providing a variation in scale to suit the local character.

Glebe Point Road

- The fourth and fifth storeys retreat northwards back into the site relative to Glebe Point Road, detracting from this street's clarity in street wall definition.

3m Setback from 255 Broadway to Glebe Point Road



View east along Broadway from Sydney University

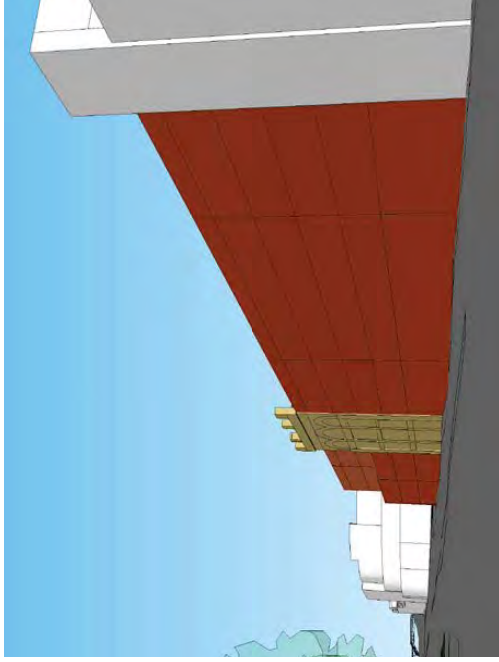

View north across Broadway from City Road

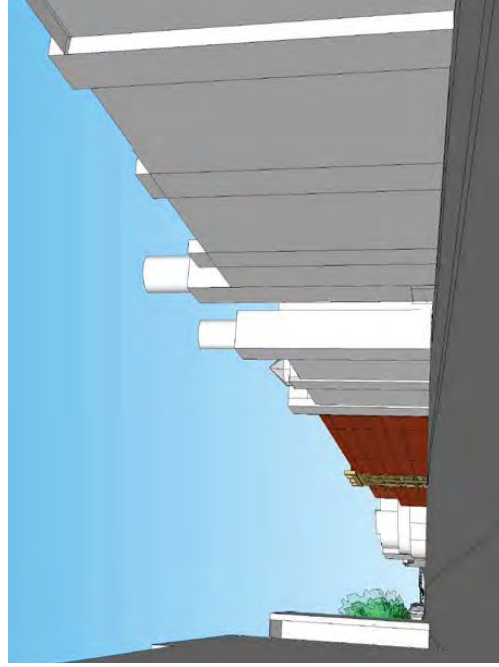

View west along Broadway from Buckland Street



View south along Glebe Point Road

Broadway

- The heritage building of 255 Broadway is utilised to provide definition between the vertical street wall (bright orange) and the setback street wall (light orange), where the fourth and fifth storeys are setback 3m.
- The sense of opening to Glebe Point Road is revealed in the Broadway facade by the setback fourth and fifth storeys to the west of 255 Broadway – even before the opening to Glebe Point Road is fully revealed from the viewer's position.

Street Corner

- A reasonably clear rounded corner is created as both the street wall and the setback levels of the building facade transition from one street to the next.

Height Transition

- The five storey height continues along the length of the Broadway and Glebe Point Road façades, necessitating that another building (ideally 1-9 Glebe Point Road) provides the step from five storeys down to two or three storeys in a future development.

Glebe Point Road

- The five storey wide space at the entrance to Glebe Point Road, as defined by the new study site building and University Hall, can function as a 'threshold' into Glebe.
- The Glebe Point Road street wall of three storeys with the top two storeys set back provides an appropriate contribution to the finer scale character of this area.

Continuous Street Wall from Broadway to Glebe Point Road



View east along Broadway from Sydney University

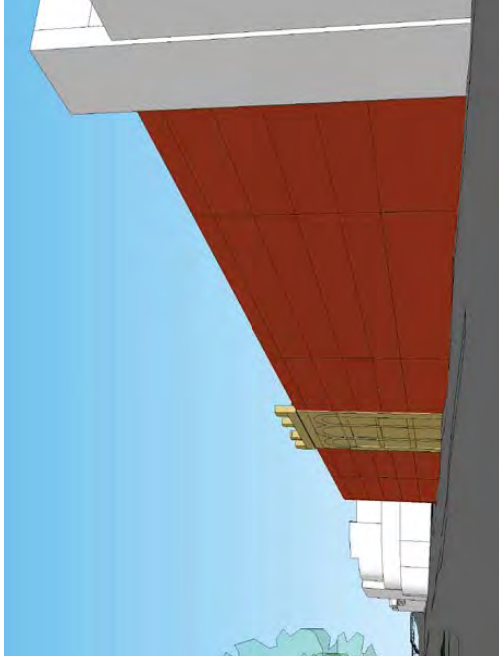

View north across Broadway from City Road

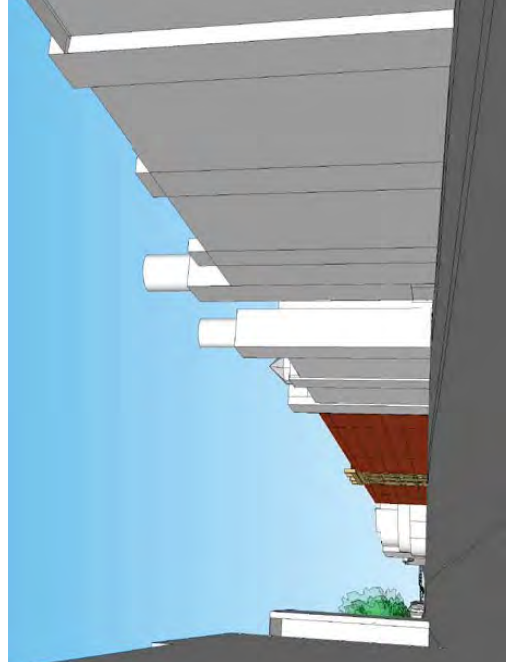

View west along Broadway from Buckland Street

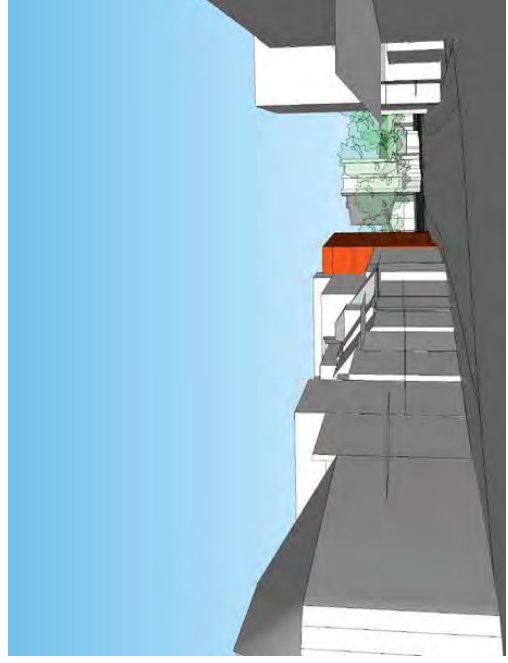

View south along Glebe Point Road

Broadway

- A continuous five storey street wall extends along Broadway from the Broadway Shopping Centre past the heritage 255 Broadway building to Glebe Point Road. This provides a strong and distinct facade along the Broadway (and Victoria Park) edge.

- Glebe Point Road is partially visible along Broadway as a rounded street wall opening.

Street Corner

- The entire five storey street wall curves around the Glebe Point Road corner, matching the University Hall facade as directly as possible. Together, these buildings will provide strong definition to the Glebe Point Road gateway.

Height Transition

- The five storey height continues along the length of the Broadway and Glebe Point Road façades, necessitating that another building (ideally 1-9 Glebe Point Road) provides the step from five storeys down to two or three storeys in a future development.

Glebe Point Road

- The five storey wide space at the entrance to Glebe Point Road, as defined by the new study site building and University Hall, can function as a 'threshold' into Glebe.

- The five storey street wall to Glebe Point Road matches University Hall as a marker to the Broadway intersection, but requires a well-designed treatment for the exposed end party wall, and also that neighbouring properties successfully negotiate the height transition from Broadway into Glebe.



LANE 6-10 3-7 MON-FRI

KING

4 Appendix:

Design Development



4.1 Generic Typology Studies

Podium Block Types

Assumptions:

- Depth ranges from 33 to 34m (typical block)
- Frontages range from 19-23m
- Area per lot ranges from 645 to 775 m²
- Heights capped at 4-5 storeys

Typical Characteristics:

- Ground floor to Broadway retained as commercial or retail use.
- Typical built form arranged around a central or side core + circulation
- Open communal spaces are typically located in the middle of the lot and elevated above the level of Broadway and Grose Street.

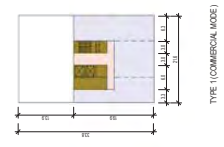

ADG (RESIDENTIAL)	Y (2/3)
CROSS VENT (80% req)	Y (2/3)
SOLAR ACCESS (70% req)	Y
BUILDING SEPARATION	Y

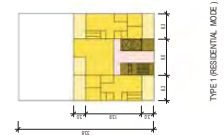

ADG (RESIDENTIAL)	Y (4/4)
CROSS VENT (80% req)	N (2/4)
SOLAR ACCESS (70% req)	N (2/4)
BUILDING SEPARATION	N

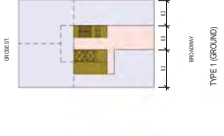

ADG (RESIDENTIAL)	Y (4/4)
CROSS VENT (80% req)	Y (4/4)
SOLAR ACCESS (70% req)	Y (4/4)
BUILDING SEPARATION	Y

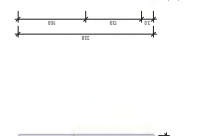

ADG (RESIDENTIAL)	Y (4/4)
CROSS VENT (80% req)	N (2/4)
SOLAR ACCESS (70% req)	N
BUILDING SEPARATION	N

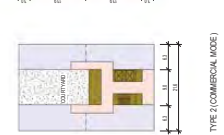

ADG (RESIDENTIAL)	Y (4/4)
CROSS VENT (80% req)	Y (4/4)
SOLAR ACCESS (70% req)	N (2/4)
BUILDING SEPARATION	Y

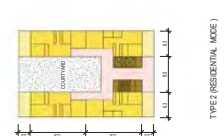

ADG (RESIDENTIAL)	Y (4/4)
CROSS VENT (80% req)	N (2/4)
SOLAR ACCESS (70% req)	N (2/4)
BUILDING SEPARATION	Y

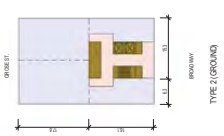

ADG (RESIDENTIAL)	Y (4/4)
CROSS VENT (80% req)	Y (4/4)
SOLAR ACCESS (70% req)	N (2/4)
BUILDING SEPARATION	Y

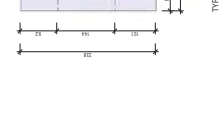

ADG (RESIDENTIAL)	Y (4/4)
CROSS VENT (80% req)	Y (4/4)
SOLAR ACCESS (70% req)	N (2/4)
BUILDING SEPARATION	Y

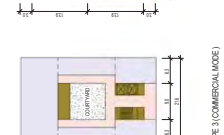

ADG (RESIDENTIAL)	Y (4/4)
CROSS VENT (80% req)	Y (2/3)
SOLAR ACCESS (70% req)	Y (2/3)
BUILDING SEPARATION	Y

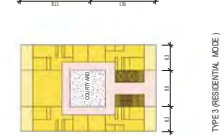

ADG (RESIDENTIAL)	Y (4/4)
CROSS VENT (80% req)	Y (2/3)
SOLAR ACCESS (70% req)	Y (2/3)
BUILDING SEPARATION	Y

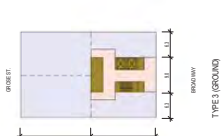

ADG (RESIDENTIAL)	Y (4/4)
CROSS VENT (80% req)	Y (2/3)
SOLAR ACCESS (70% req)	Y (2/3)
BUILDING SEPARATION	Y



ADG (RESIDENTIAL)	Y (4/4)
CROSS VENT (80% req)	Y (2/3)
SOLAR ACCESS (70% req)	Y (2/3)
BUILDING SEPARATION	Y

Podium Block + Tower

Assumptions:

- Depth ranges from 33 to 34m (typical block)
- Frontages range from 22.5 to 39m
- Area per lot ranges from 760 to 1320m².
- Podium heights capped at 4-5 storeys
- Tower heights above podium may be varied according to overshadowing requirements.

Typical Characteristics:

- Ground floor to Broadway retained as commercial or retail use.
- Podium floors proposed as commercial use as strata offices with dedicated vertical circulation.
- Podium floor plates set back at side boundaries to provide natural light to commercial spaces.
- Communal open space for residents located at podium rooftop level.
- Residential apartments located above street-wall podium.
- Apartments arranged around central core to maximise apartment aspect.
- Zero setback to front, rear and side boundaries.

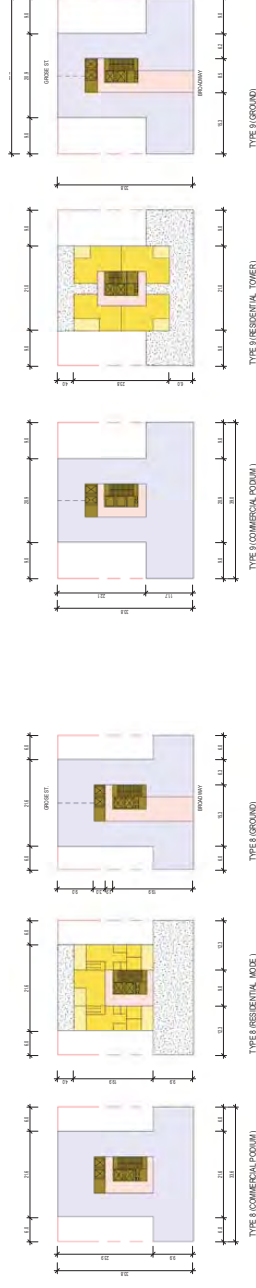

AGO (RESIDENTIAL)	N (2/2)
CROSS VENT (60% REQ)	N (4/4)
SOLAR ACCESS (70% REQ)	N (3/3)
BUILDING SEPARATION	Y

AGO (RESIDENTIAL)	N (4/4)
CROSS VENT (60% REQ)	N (4/4)
SOLAR ACCESS (70% REQ)	N (4/4)
BUILDING SEPARATION	Y

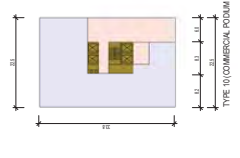
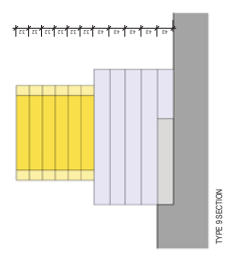

AGO (RESIDENTIAL)	N (2/2)
CROSS VENT (60% REQ)	N (2/2)
SOLAR ACCESS (70% REQ)	N (2/2)
BUILDING SEPARATION	Y

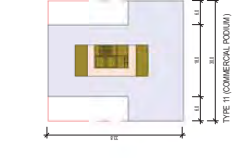

AGO (RESIDENTIAL)	N (4/4)
CROSS VENT (60% REQ)	N (4/4)
SOLAR ACCESS (70% REQ)	N (4/4)
BUILDING SEPARATION	Y

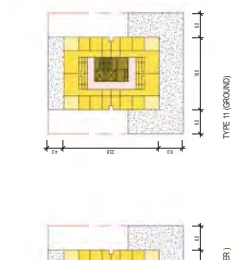

Narrow Lot Typologies

Assumptions:

- Depth ranges from 33 to 34m (typical block)
- Frontages range from 5 to 10m
- Area per lot ranges from 170 to 340m².
- Podium heights capped at 4-5 storeys

Typical Characteristics:

- Ground floor to Broadway retained as commercial or retail use.
- Typical built form arranged around a central or side core + circulation
- Open communal spaces are typically located in the middle of the lot and elevated above the level of Broadway and Grose Street.

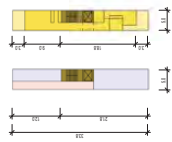

TYPE 11

AGD (RESIDENTIAL)	
CROSS VENT (60% max)	Y/20
SOLAR ACCESS (70% max)	Y/20
BUILDING SEPARATION	Y

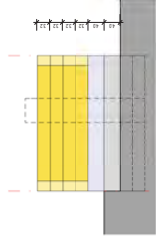

TYPE 11 SECTION

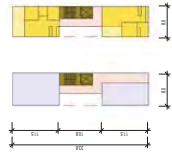

TYPE 12

AGD (RESIDENTIAL)	
CROSS VENT (60% max)	Y/20
SOLAR ACCESS (70% max)	Y/20
BUILDING SEPARATION	Y

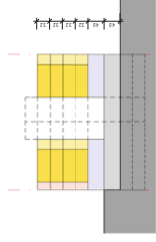

TYPE 12 SECTION

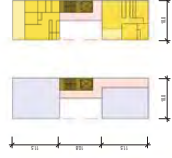

TYPE 13

AGD (RESIDENTIAL)	
CROSS VENT (60% max)	Y/20
SOLAR ACCESS (70% max)	Y/20
BUILDING SEPARATION	Y

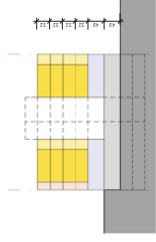

TYPE 13 SECTION

Shallow Lot Typologies

Assumptions:

- Shallowest block depth from 18.5m
- Frontages range from 23.5 to 46m
- Area per lot ranges from 170 to 340m².
- Podium heights capped at 4-5 storeys

Typical Characteristics:

- Ground floor to Broadway retained as commercial or retail use.
- Typical built form places circulation spaces to Broadway to mitigate noise, lift core to one side and open communal space to the north. All apartments orientated north.
- Open communal spaces located at Broadway level, above Grose Street.
- Zero setback to front, rear and side boundaries.

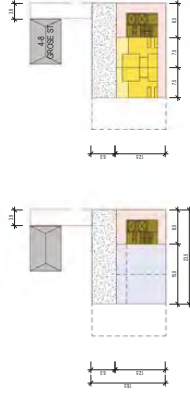

TYPE 14 (COMMERCIAL OPTION)

AGD (RESIDENTIAL)	
CROSS VENT (60% max)	N/10
SOLAR ACCESS (70% max)	Y/10
BUILDING SEPARATION	Y

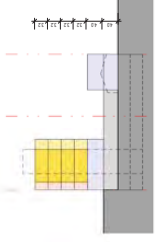

TYPE 14 SECTION

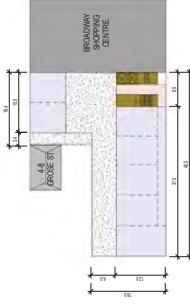

TYPE 14 (RESIDENTIAL OPTION)

AGD (RESIDENTIAL)	
CROSS VENT (60% max)	N/10
SOLAR ACCESS (70% max)	Y/10
BUILDING SEPARATION	Y

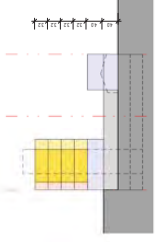

TYPE 14 SECTION

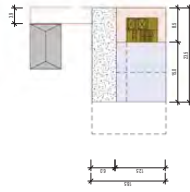

TYPE 15

AGD (RESIDENTIAL)	
CROSS VENT (60% max)	N/20
SOLAR ACCESS (70% max)	Y/20
BUILDING SEPARATION	Y

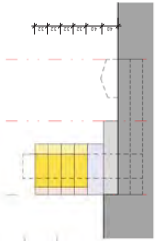

TYPE 15 SECTION

4.2 Sectional Studies

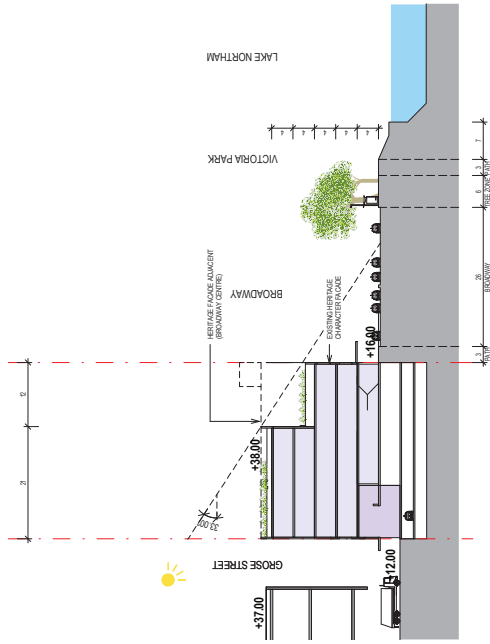

Study 1

Podium

- Considers the preservation of existing fine grain façades e.g.: 225-227 Broadway (next to Broadway shopping centre)
- Potential for boutique retail frontages to Grose Street and Broadway
- Upper floor plates may accommodate small boutique commercial suites.
- Communal terrace space at upper levels to serve boutique commercial suites.
- Solar

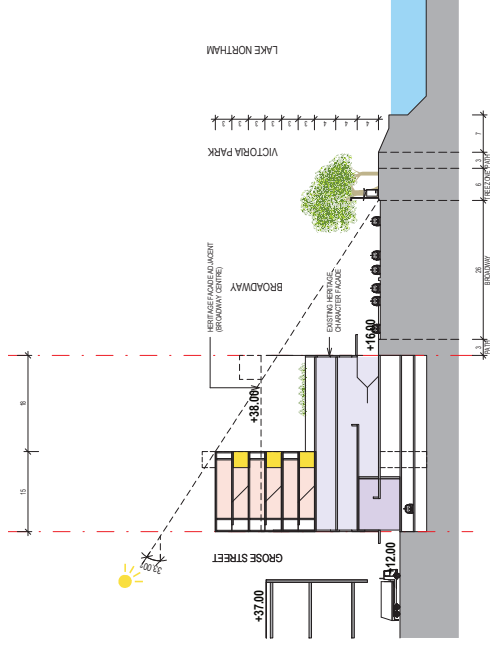

Study 2

Podium

- Considers the preservation of existing fine grain façades e.g.: 225-227 Broadway (next to Broadway shopping centre)
- Any additional development is set back 18m to minimise noise impact from Broadway.
- Potential for boutique retail frontages to Grose Street and Broadway
- Upper floor plates consist of a small portion of slender dual aspect apartments, single loaded with views to the north (Grose Street)
- Communal terrace space serve residents of residential development

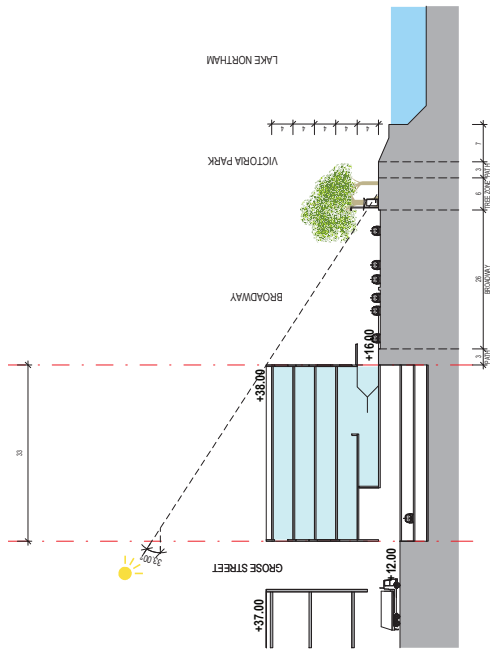

Study 3

Podium

- Loading and parking facilitated from Grose Street.
- Ground floor retail interface to Broadway
- Large floor plates at upper levels to accommodate a range of uses including teaching + learning spaces

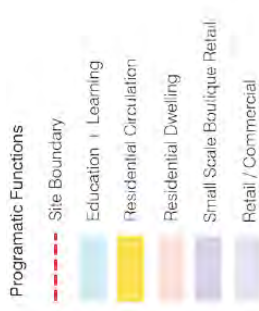

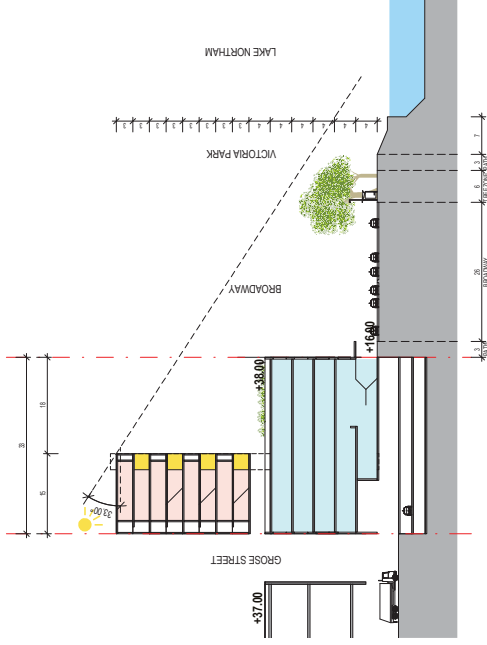

Study 4

Podium

- Loading and parking facilitated from Grose Street.
- Communal open space located overlooking Broadway
- Ground floor retail interface to Broadway
- Large floor plates at upper levels to accommodate a range of uses including teaching + learning spaces

Tower

- Residential component elevated above podium level for improved acoustic isolation from traffic noise
- Narrow building typology (15m width) with a 18m setback to Broadway
- Double level / dual aspect apartments with perimeter circulation
- Primary orientation of apartments to of the city + solar access (Grose Street)
- South facing open communal green space at podium rooftop level

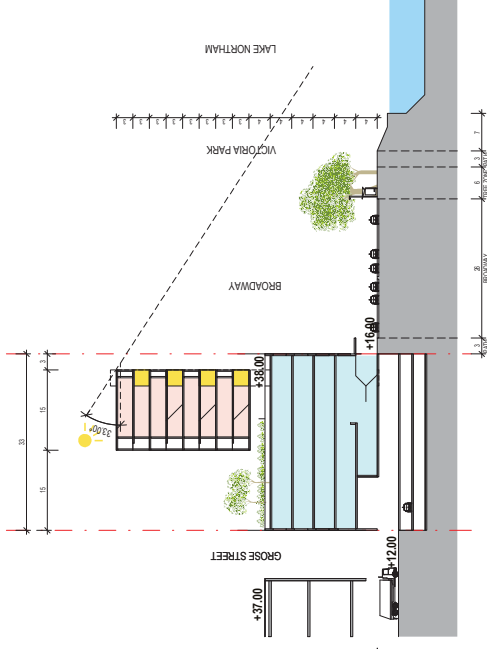

Study 5

Tower

- Elevated residential component for improved acoustic isolation from traffic noise
- Narrow building typology (15m width) with a 3m setback to Broadway and 15m setback from Grose street.
- Double level / dual aspect apartments with perimeter circulation
- Primary orientation of apartments to of the city + solar access (Grose Street)
- North facing open communal green space at podium rooftop level
- Additional height above the existing heritage buildings will result in overshadowing to Victoria Park and will be inconsistent with the street wall height established by heritage buildings.
- All balconies to include an external and internal line of glazing to maximise acoustic attenuation

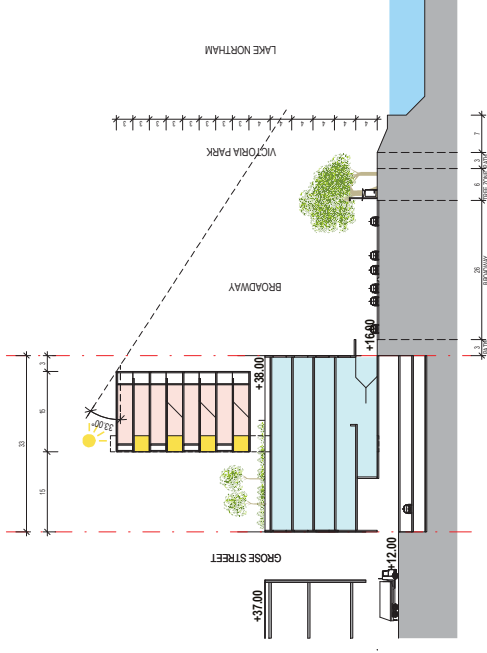

Study 6

Tower

- Elevated residential component for improved acoustic isolation from traffic noise
- Narrow building typology (15m width) with a 3m setback to Broadway and 15m setback from Grose Street.
- Double level / dual aspect apartments with perimeter circulation
- Primary orientation of apartments address the view to Victoria Park (Broadway)
- North facing open communal green space at podium rooftop level.
- Additional height above the existing heritage buildings will result in overshadowing to Victoria Park and will be inconsistent with the street wall height established by heritage buildings.
- All balconies to include an external and internal line of glazing to maximise acoustic attenuation.

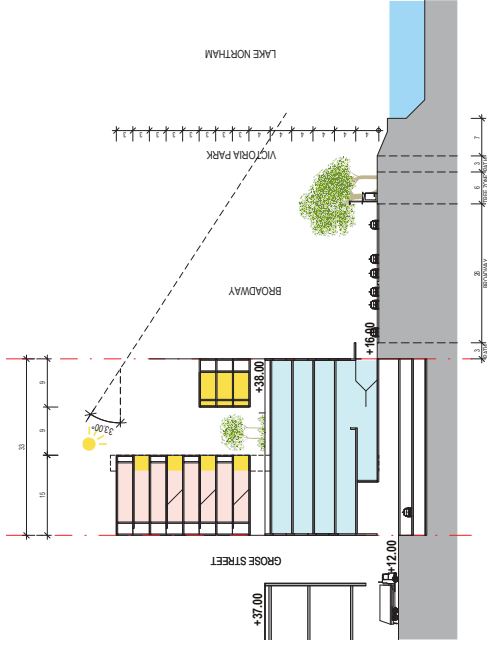

Study 7

Tower(s)

- Elevated residential component for improved acoustic isolation from traffic noise
- Composed of two components: 1. A narrow building typology (15m width) with zero setback to Grose Street and 2. A walk-up typology fronting Broadway
- Double level / dual aspect apartments with perimeter circulation
- Primary orientation of apartments address the view to Victoria Park (Broadway)
- North facing open communal green space at podium rooftop level.
- Additional height above the existing heritage buildings will result in overshadowing to Victoria Park and will be inconsistent with the street wall height established by heritage buildings.
- All balconies to include an external and internal line of glazing to maximise acoustic attenuation

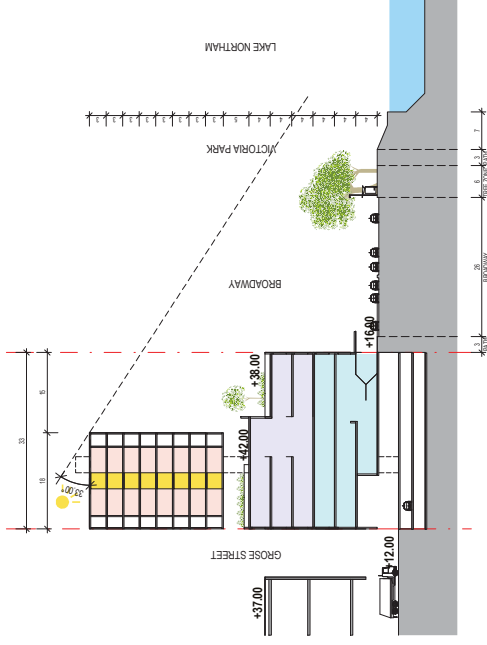

Study 8

Podium

- Floor plates punctuated by central voids and atrium to provide natural light
- Loading and parking facilitated from Grose Street.
- Communal open space located overlooking Broadway

Tower

- Elevated residential component for improved acoustic isolation from traffic noise
- Stepped podium to provide greater height
- Wider building typology (18m width) with a 15m setback to Broadway
- Single level/ single aspect apartments + central circulation
- Access to views (Broadway) and sunlight (Grose Street)
- All balconies to include an external and internal line of glazing to maximise acoustic attenuation
- Additional height above the existing heritage buildings will result in overshadowing to Victoria Park and will be inconsistent with the street wall height established by heritage buildings.
- Suitable for a large amalgamated site (> 1000 sqm.)

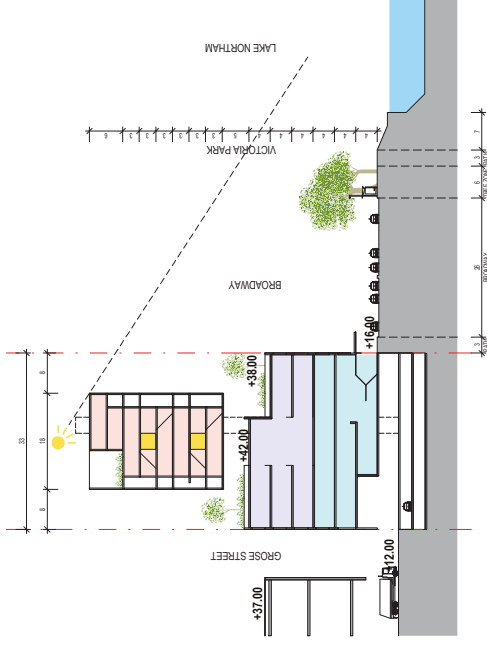

Study 9

Tower

- Elevated residential component for improved acoustic isolation from traffic noise
- Wider building typology (18m width) with a 8m setback to Broadway and Grose Street
- Double level / dual aspect apartments + central circulation
- Access to views (Broadway) and sunlight (Grose Street)
- All balconies to include an external and internal line of glazing to maximise acoustic attenuation
- North facing residential communal spaces
- Additional height above the existing heritage buildings will result in overshadowing to Victoria Park and will be inconsistent with the street wall height established by heritage buildings.
- Suitable for a large amalgamated site (> 1000 sqm.)

4.3 Exploratory Options Testing

Exploratory Option – Existing Ownership Pattern

This option examines the potential for development based upon the current ownership of lots, without amalgamation.

Heritage Interface:

- 4-5 storey continuous street wall along Broadway and a transition down to 2-3 storeys in the Glebe Point Road Conservation area.
- Option assumes both 225 Broadway (1D) and 4-8 Grose Street (1G) are retained as heritage items.

Site Connectivity:

- A through site link is established on the western boundary on Glebe Point Road to improve block connectivity.

Built Form and Active Frontage:

- The ground floor of all development is designated retail to maintain street activation to Broadway.
- Lot 1F is land-locked and could not undergo redevelopment.

Solar Access and Natural Ventilation:

- Where possible, apartments within developments are single aspect apartments with gallery access, orientated north to maximise solar access and cross ventilation.
- Narrower developments are composed of dual aspect, single storey apartments (1 per floor) to achieve solar access and cross ventilation.

Noise:

- Apartments will need to acoustic attenuation to mitigate noise from Broadway and the Shopping Centre.

Views:

- Most development lots receive access to views of Victoria Park

Typical Podium Level

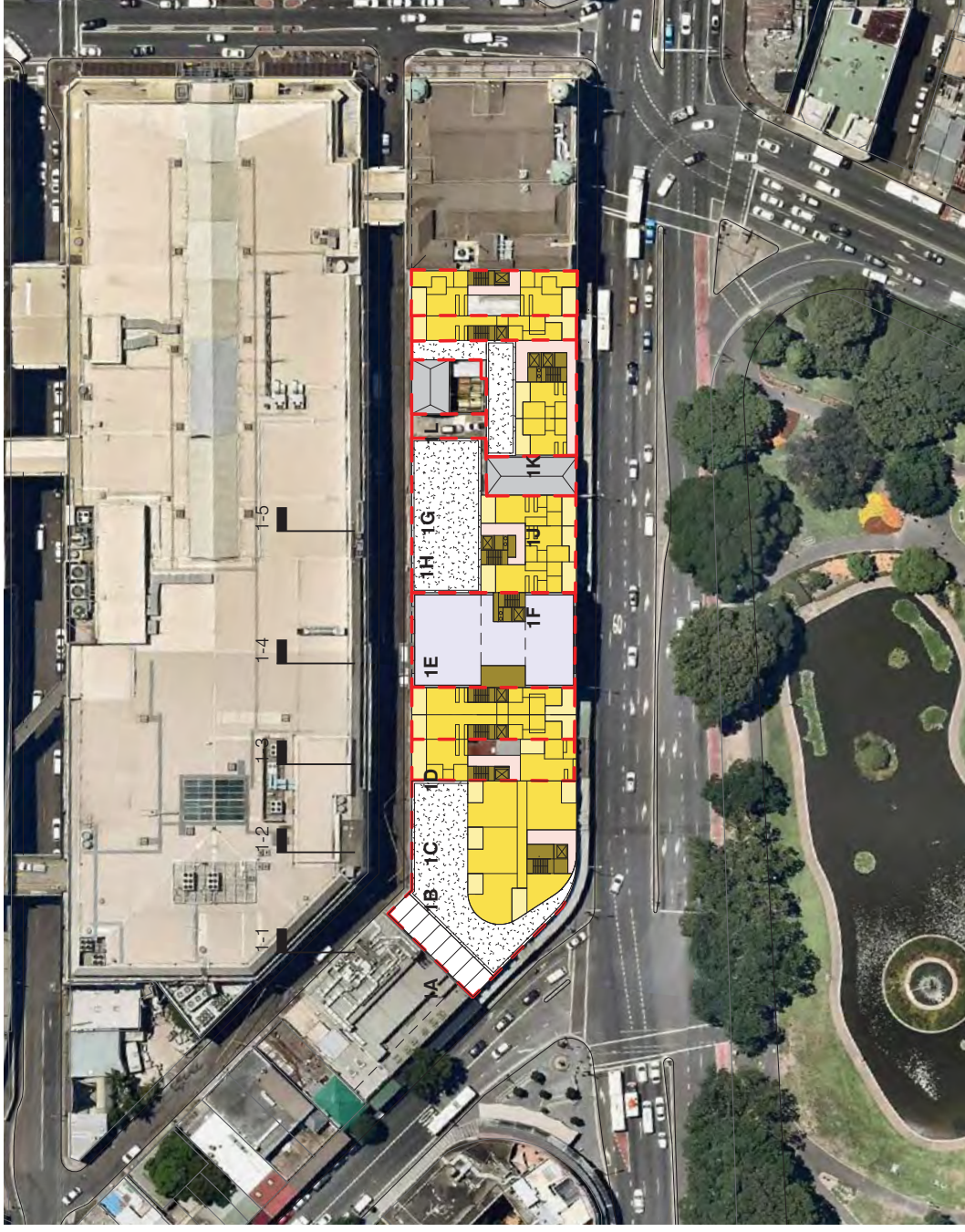

Sections

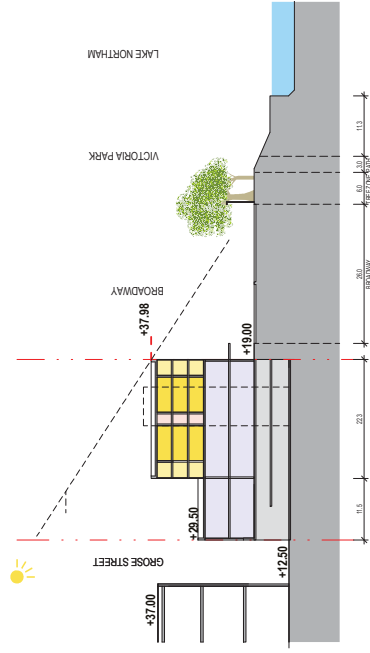

Section 1-1

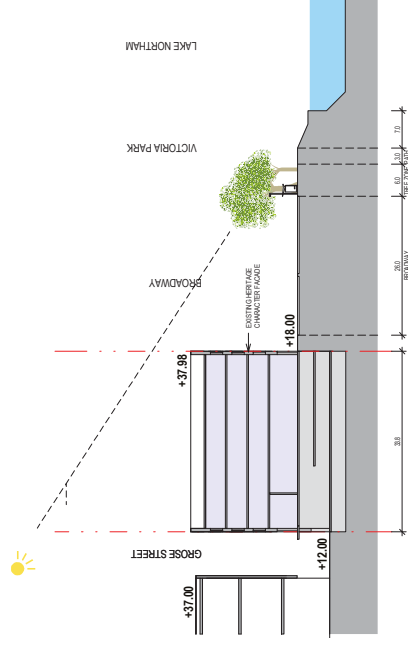

Section 1-3

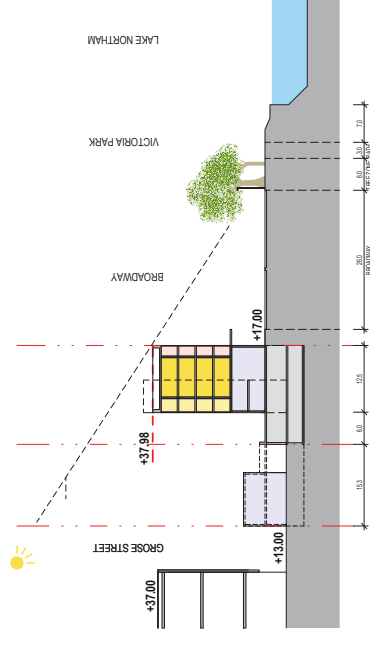

Section 1-5

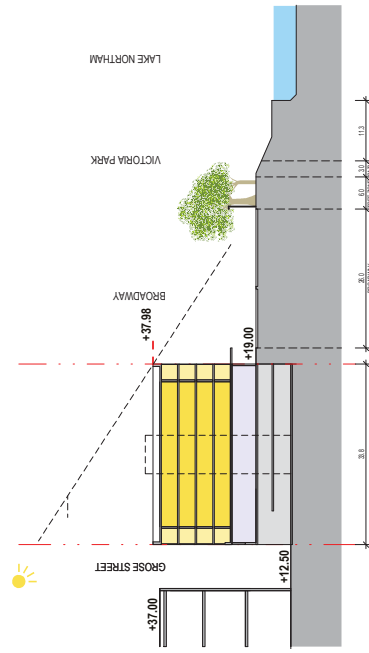

Section 1-2

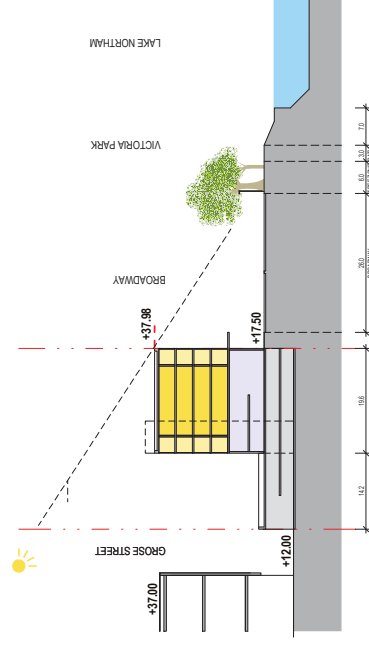

Section 1-4

Option 1 - Site Wide Key Summary	
Site Area	4,730
GFA Achieved	12,648
Aggregate FSR Achieved	2.67

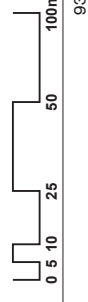

Exploratory Option – Minimum Lot Width 14m

Option 2 explores the amalgamation of smaller, narrower lots to test the capacity lots with wider frontages.

Heritage Interface:

- 4-5 storey continuous street wall along Broadway with a curved transition down to 2-3 storeys in the Glebe Point Road Conservation area.
- Option assumes both 225 Broadway (2D) and 4-8 Grose Street (2G) are retained as heritage items.

Site Connectivity:

- Two through site links are established one on the western boundary on Glebe Point Road and the other close to the eastern boundary near the Grace Bros. building.

Built Form and Active Frontage:

- 4-5 storey continuous street wall along Broadway and a transition down to 2-3 storeys on Glebe Point Road.
- The ground floor of all development is designated retail to maintain street activation to Broadway.

Solar Access and Natural Ventilation:

- Where possible, apartments within developments are single aspect apartments with gallery access, orientated north to maximise solar access and cross ventilation.
- Single aspect courtyard apartments types developed to incorporate cross ventilation. North facing apartments receive good access to sunlight but no views.

Noise:

- Apartments will need to acoustic attenuation to mitigate noise from Broadway and the Shopping Centre.

Views:

- Apartments facing Victoria Park received good views but poor solar access.

Typical Podium Level

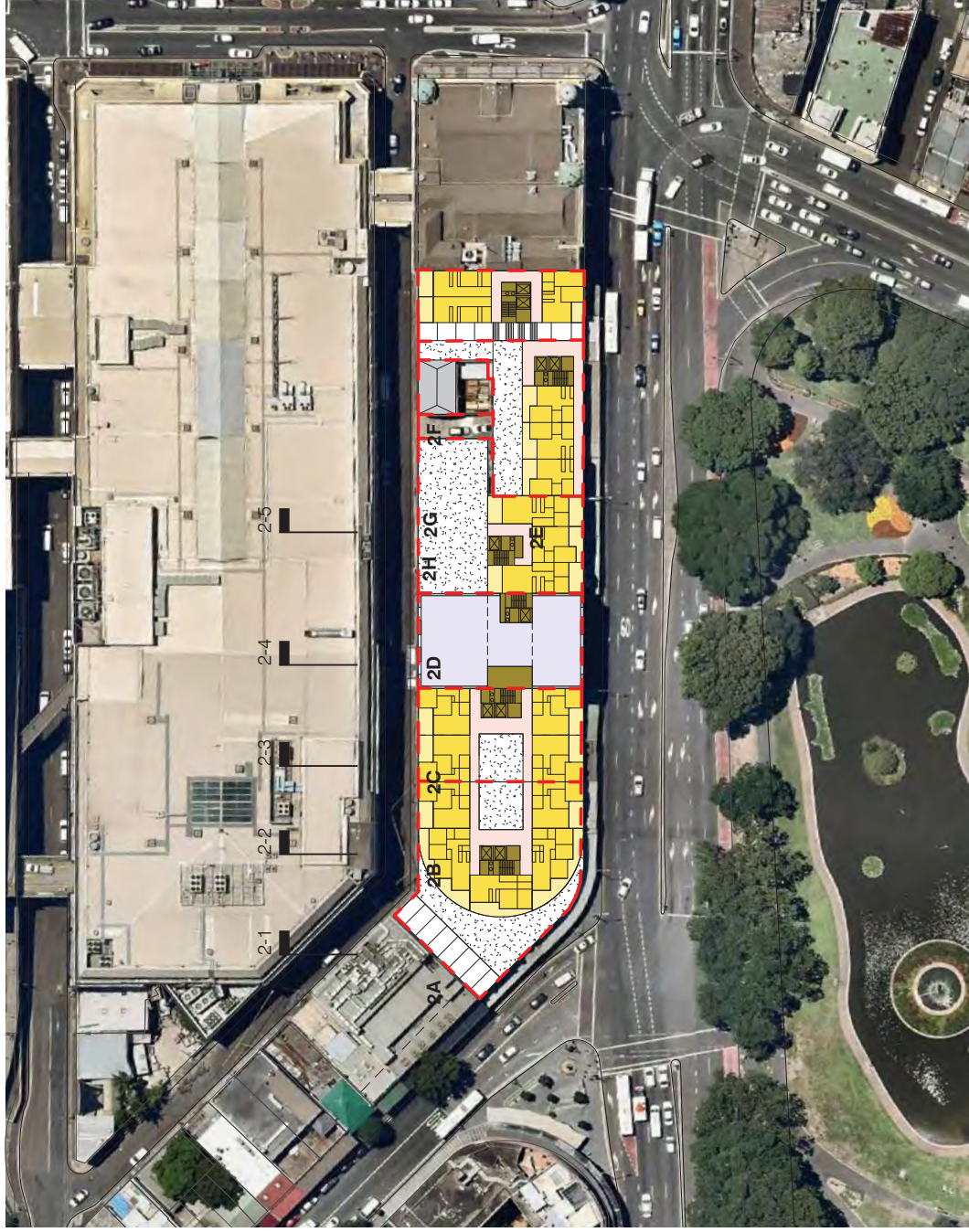

Sections

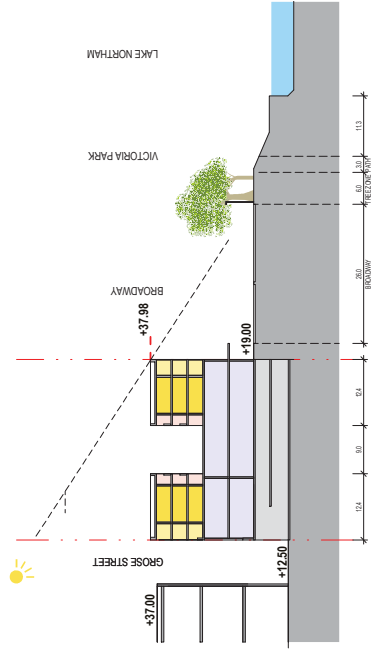

Section 2-1

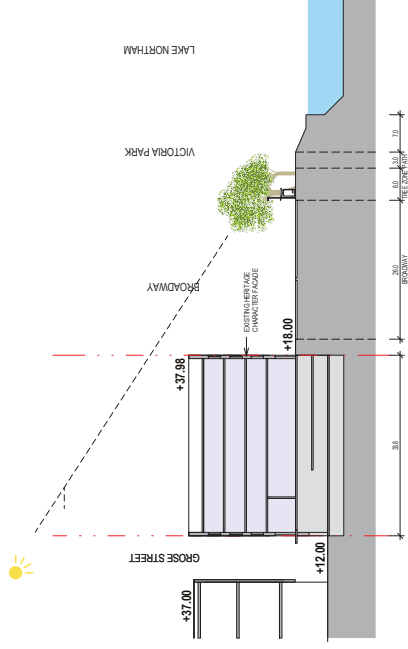

Section 2-3

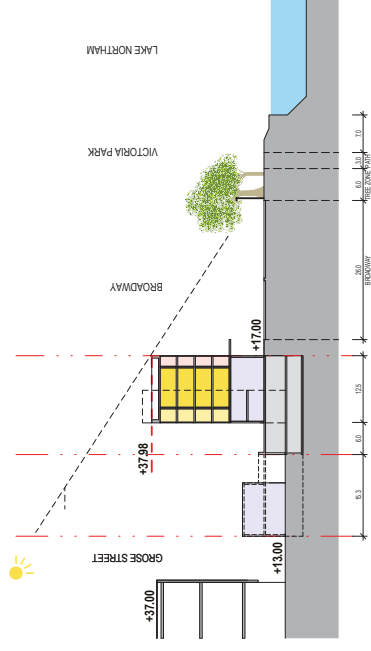

Section 2-5

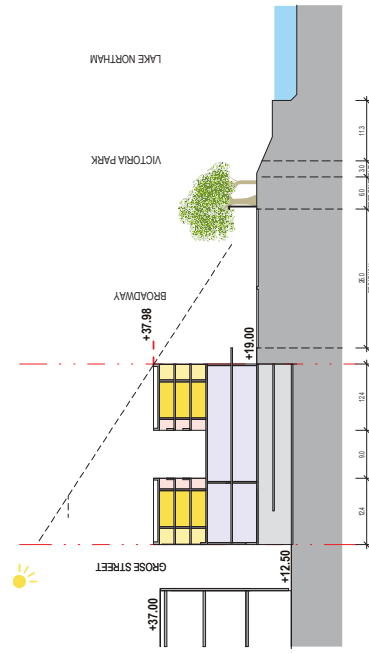

Section 2-2

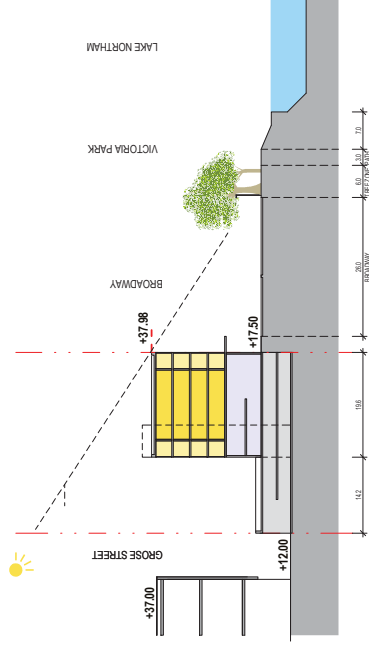

Section 2-4

Option 2 - Site Wide Key Summary

Site Area	4,730
GFA Achieved	12,842
Aggregate FSR Achieved	2.72



Exploratory Option – Minimum Lot Width 25m

Builds on Option 2 and explores the potential for additional height based on larger lot sizes and examines the development potential for additional floor space in excess of the podium datum.

Heritage Interface:

- 4-5 storey continuous street wall along Broadway and into the Glebe Point Road Conservation area.
- Option assumes both 225 Broadway (3D) and 4-8 Grose Street (3G) are retained as heritage items.

Site Connectivity:

- Two through site links are established one on the western boundary on Glebe Point Road and the other, a mid block connection on Broadway.

Built Form and Active Frontage:

- 4-5 storey continuous street wall along Broadway and a curved built form transition to Glebe Point Road.
- Tower blocks located in lots (3A and 3D) up to 12 storeys in height, set back from Broadway and Glebe Point Road.
- Tower block 3A designed to be 'in the round' to provide a sympathetic response to the predominantly 2-3 storey Glebe Point Road conservation area

Solar Access and Natural Ventilation:

- As per Option 2.

Noise:

- As per Option 2.

Views:

- Views to towers are maximised to take advantage of both city and park views.

Typical Podium Level

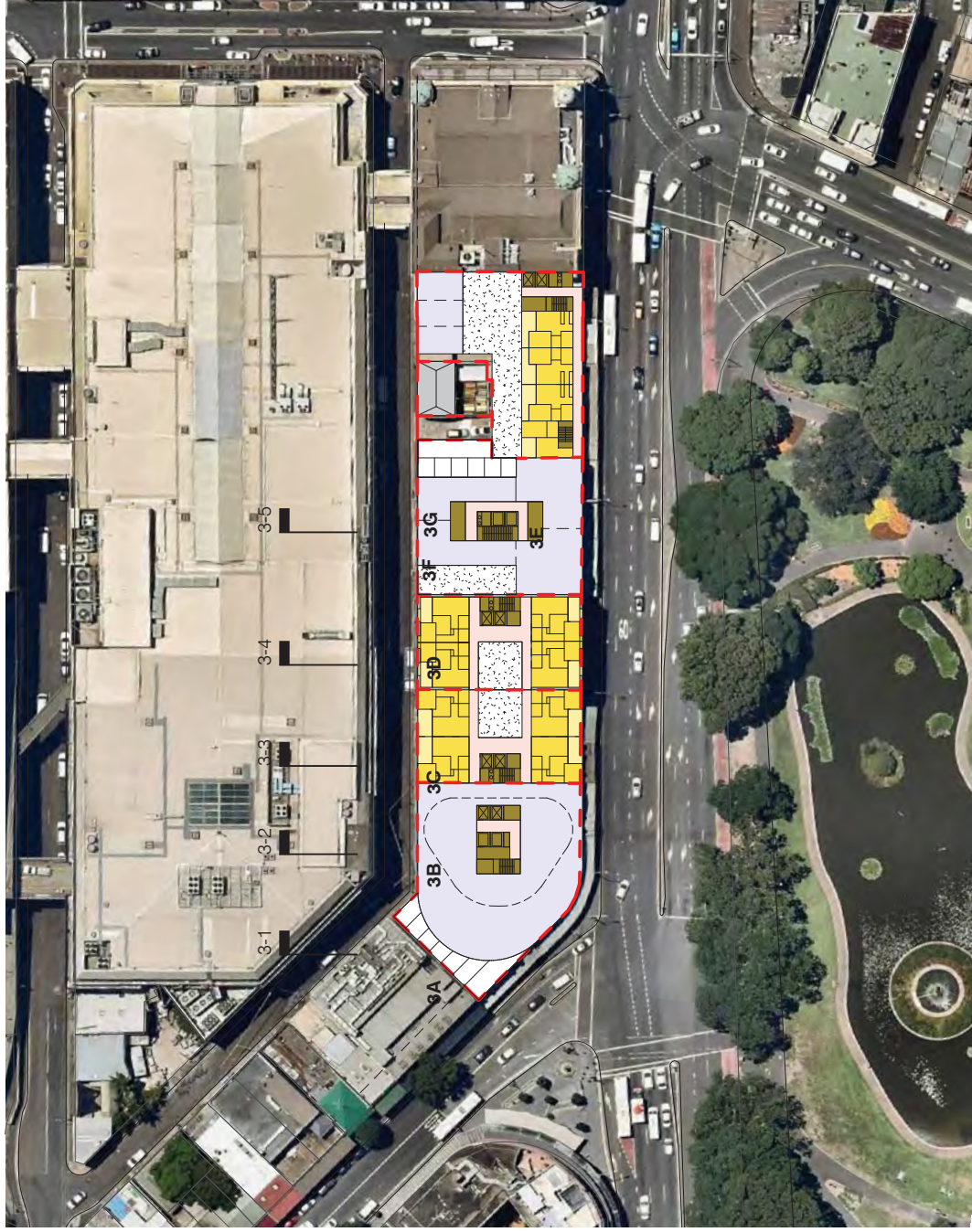

Tower Level

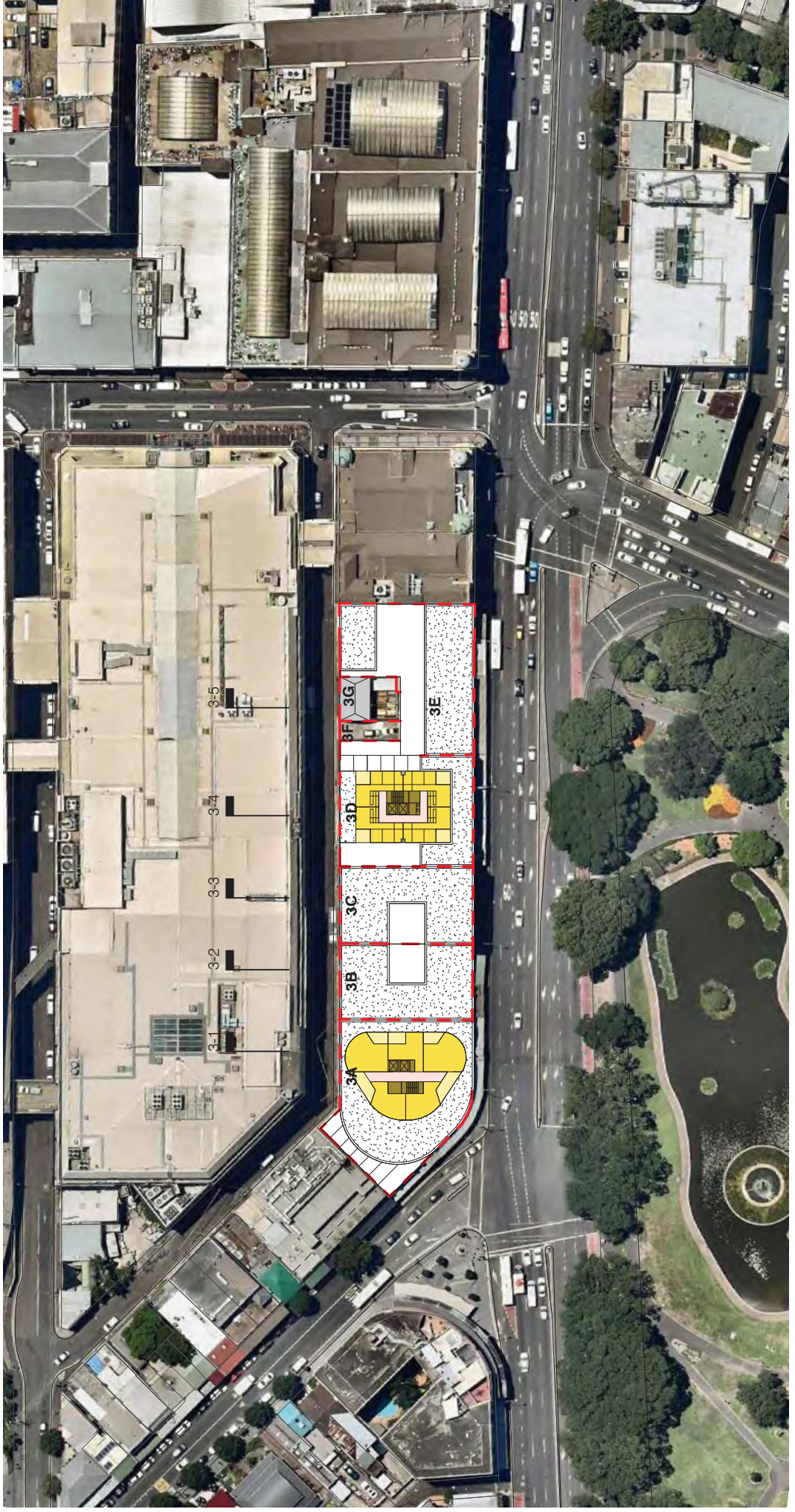

Sections

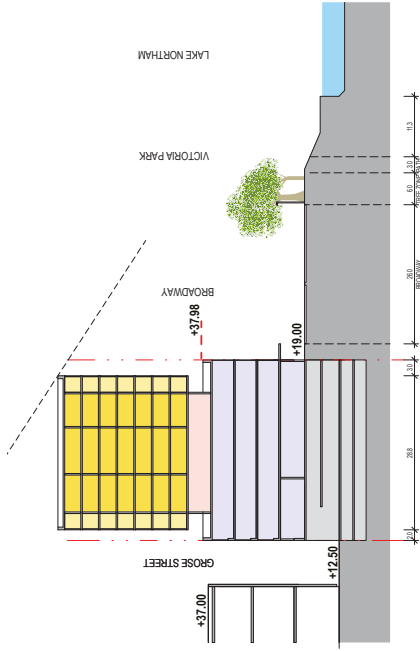

Section 3-1

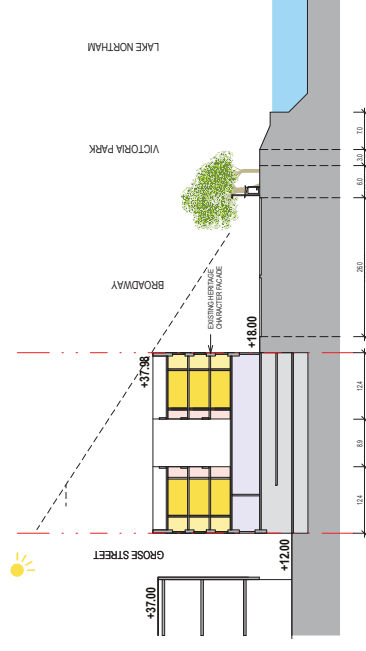

Section 3-3

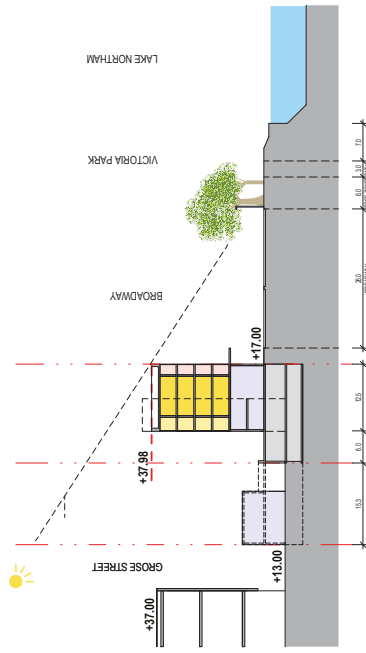

Section 3-5

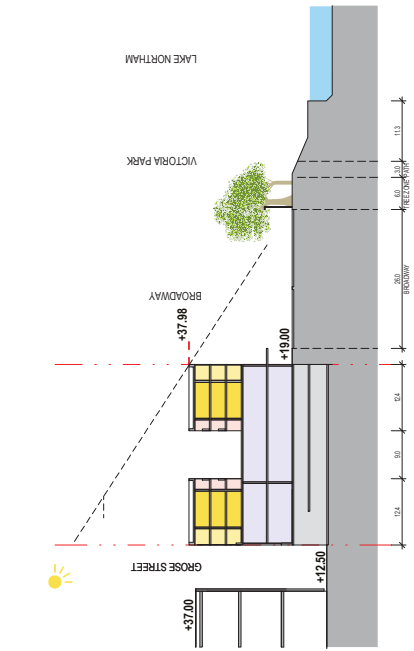

Section 3-2

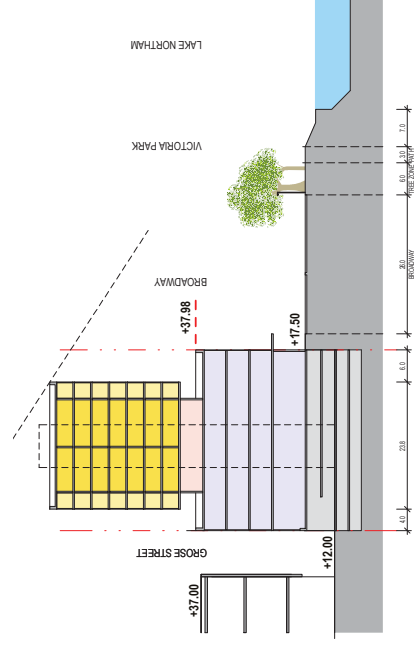

Section 3-4

Option 3 - Site Wide Key Summary	
Site Area	4,730
GFA Achieved	17,735
Aggregate FSR Achieved	3.75

4.4 Summary of Areas

Option 1

Indicative Schedule of Areas

Level	Lot 1A		Lot 1B		Lot 1C		Lot 1D		Lot 1E		Lot 1F		Lot 1G		Lot 1H		Lot 1J		Lot 1K		Lot 1L	
	Comm	Res	Comm	Res	Comm	Res	Comm	Res	Comm	Res	Comm	Res	Comm	Res	Comm	Res	Comm	Res	Comm	Res	Comm	Res
L01 - <i>Basement Entry</i>	905	0	291	0	508	0	508	0	326	0	150	0	90	0	234	0	117	0	138	0	273	0
L02	905	0	175	0	222	508	0	326	0	150	0	90	0	234	0	117	0	138	0	273	0	
L03	0	432	0	175	0	222	508	0	0	247	0	90	0	0	210	0	210	0	100	0	227	0
L04	0	432	0	175	0	222	508	0	0	247	0	90	0	0	210	0	210	0	100	0	227	0
L05	0	432	0	175	0	222	508	0	0	247	0	90	0	0	210	0	210	0	100	0	227	0
L06	0	432	0	175	0	222	508	0	0	247	0	90	0	0	210	0	210	0	100	0	227	0
<i>Roof Plant (Excluded)</i>																						
Subtotal	1811	1397	291	891	2033	891	2033	891	652	988	300	0	90	0	0	0	351	840	276	418	596	908
Total GFA	3107	960	1190	2033	1660	300	90	90	1660	300	300	90	90	1660	300	0	1191	684	684	1054	1654	2142
Site Area	1215	282	356	641	852	150	76	76	852	150	76	76	852	150	76	76	852	150	76	76	852	150
FSR	2.6:1	3.4:1	3.3:1	3.2:1	1.9:1	2.0:1	0.5:1	0.5:1	0.5:1	0.5:1	0.5:1	0.5:1	0.5:1	0.5:1	0.5:1	0.5:1	2.4:1	4.0:1	4.0:1	4.0:1	4.6:1	4.6:1

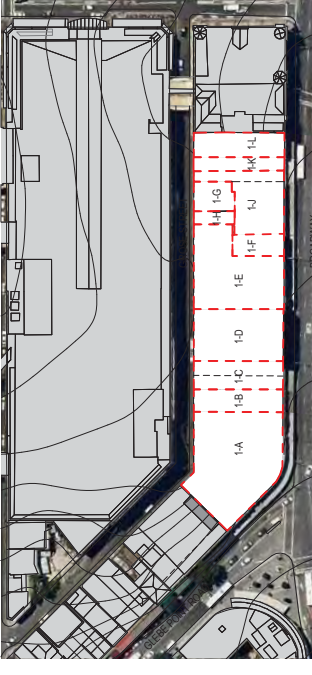

Option 2

Indicative Schedule of Areas

Level	Lot 2A		Lot 2B		Lot 2C		Lot 2D		Lot 2E		Lot 2F		Lot 2G		Lot 2H	
	Comm	Res	Comm	Res	Comm	Res	Comm	Res	Comm	Res	Comm	Res	Comm	Res	Comm	Res
L01 - <i>Basement Entry</i>	905	0	600	0	508	0	338	0	331	0	293	0	90	0	0	0
L02	905	0	600	0	508	0	338	0	165	0	293	0	90	0	0	0
L03	0	535	0	417	508	0	0	247	0	281	0	252	0	252	0	252
L04	0	535	0	417	508	0	0	247	0	281	0	252	0	252	0	252
L05	0	535	0	417	508	0	0	247	0	281	0	252	0	252	0	252
L06	0	535	0	417	508	0	0	247	0	281	0	252	0	252	0	252
<i>Roof Plant (Excluded)</i>																
Subtotal	1811	1605	1000	1261	2033	0	652	985	496	1125	585	1007	90	0	0	0
Total GFA	3416	2451	2033	1640	1821	0	1592	1007	1592	497	90	0	90	0	0	0
Site Area	1215	638	641	852	852	150	76	76	852	150	76	76	852	150	76	76
FSR	2.8:1	3.8:1	3.2:1	1.9:1	2.1:1	0.5:1	0.5:1	0.5:1	0.5:1	0.5:1	0.5:1	0.5:1	0.5:1	0.5:1	0.5:1	0.5:1

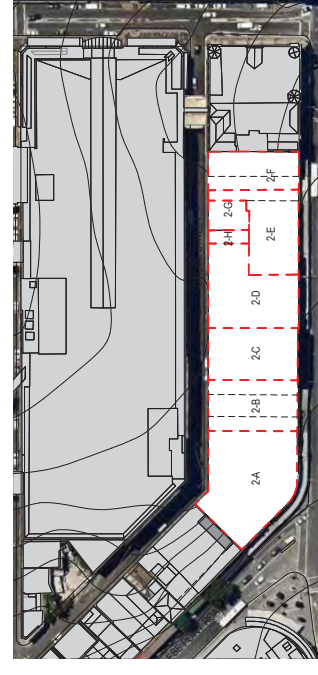

Option 3

Indicative Schedule of Areas

Level	Lot 1A		Lot 1B		Lot 1C		Lot 1D		Lot 1E		Lot 1F		Lot 1G	
	Comm	Res	Comm	Res	Comm	Res	Comm	Res	Comm	Res	Comm	Res	Comm	Res
L01 - <i>Basement Entry</i>	911	0	600	0	525	0	610	0	581	0	0	0	90	0
L02	911	0	600	0	417	0	403	0	385	0	0	0	90	0
L03	0	911	0	417	0	403	0	0	252	0	252	0	252	0
L04	0	911	0	417	0	403	0	0	252	0	252	0	252	0
L05	0	352	0	417	0	403	0	312	0	252	0	252	0	252
L06	0	352	0	417	0	403	0	312	0	252	0	252	0	252
L07-L12	0	2115	0	1876	0	1876	0	1876	0	1876	0	1876	0	1876
<i>Roof Plant (Excluded)</i>														
Subtotal	3644	2823	1000	1261	925	1003	2140	2492	1008	1007	0	0	90	0
Total GFA	6664	2451	2033	1640	4032	2073	90	90	2073	90	0	0	90	0
Site Area	1215	638	641	852	1002	992	106	106	106	106	76	76	106	106
FSR	5.3:1	3.8:1	3.2:1	1.9:1	2.1:1	2.1:1	0.5:1	0.5:1	0.5:1	0.5:1	0.5:1	0.5:1	0.5:1	0.5:1

